

**NEW EDITION**

Extraction Sets  
Extracting Forceps  
Root Elevators  
Bone Rongeurs  
Orthodontic Pliers  
Scalers  
Impression Trays

# DENTAL INSTRUMENTS

*High Quality Instruments*



**SMILES & STYLES  
ENTERPRISES**

**MANUFACTURER & EXPORTER OF SURGICAL, DENTAL AND BEAUTY TOOLS IN SIALKOT**

Address: Defence Road Sialkot - Pakistan.

Email: [info@smilesandstylesent.com](mailto:info@smilesandstylesent.com)

Website: [www.smilesandstylesent.com](http://www.smilesandstylesent.com)

Instagram: <https://www.instagram.com/smilesandstylesdnt11>

Facebook: <https://www.facebook.com/profile.php?id=61558284358720&mibextid=ZbWKwL>

### Dear Valued Buyers

We feel immense pleasure to present our latest catalogue in which we have featured a most comprehensive range of all types of quality Surgical & Dental instruments required for day to day use for Hospital. We will be pleased to quote you a competitive Price and Delivery time.

All instruments are manufactured according to the recognized standard patterns currently in use in Hospital throughout the world and are being produced under restrict control of experts to avoid any flaw and to refrain any complaint at any stage.

A group of very vast experienced persons in manufacturing handling our quality Control System.

Any instruments proven defective in workmanship or material will be replaced with out charges.

We express our thanks to all our customers for the confidence they have placed us in the past. We further assure them that we will continue our best efforts to gain their confidence in the future.

We are always at your service.

**01**

**EXTRACTING FORCEPS**

**Page # 01 - 28**

**02**

**ROOT ELEVATORS**

**Page # 29 - 48**

**03**

**DIAGNOSTIC, PROBES, SCALERS, FILLING  
& LABORATORY INSTRUMENTS**

**Page # 49 - 98**

**04**

**MAXILLOFACIAL SURGERY  
INSTRUMENTS**

**Page # 99 - 124**

**05**

**ORTHODONTIC INSTRUMENTS  
& PLIERS**

**Page # 125 - 144**

**06**

**DENTAL IMPLANT INSTRUMENTS  
& Impression Tray**

**Page # 145 - 182**

**07**

**HOLLOWWARE**

**Page # 183 - 191**



## Handle Selection For Extracting Forceps

Dear Valued Buyers if any Universal Fig. No. of Extracting Forceps not Found in our Catalogue you Can Refer the Fig. No. From These Diagram.

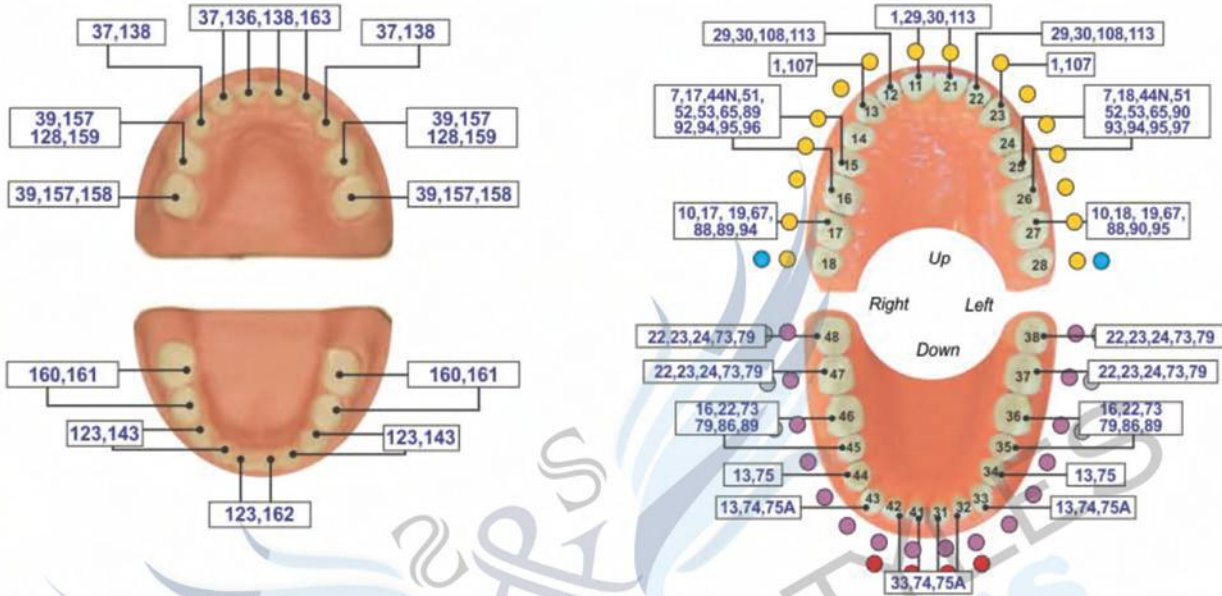

Dear Valued Buyers these are our Handle Styles





## EXTRACTING FORCEPS (English Pattern)

- Щипцы экстракционные (английская форма)
- Daviers (Forme Anglaise)
- Zahnzangen (Englische Form)
- Щипці екстракційні (англійська форма)
- Forceps de Extracción (Forme Inglesa)
- استخراج المنقط (نمط اللغة الإنجليزية)

Function: To remove teeth from bony socket

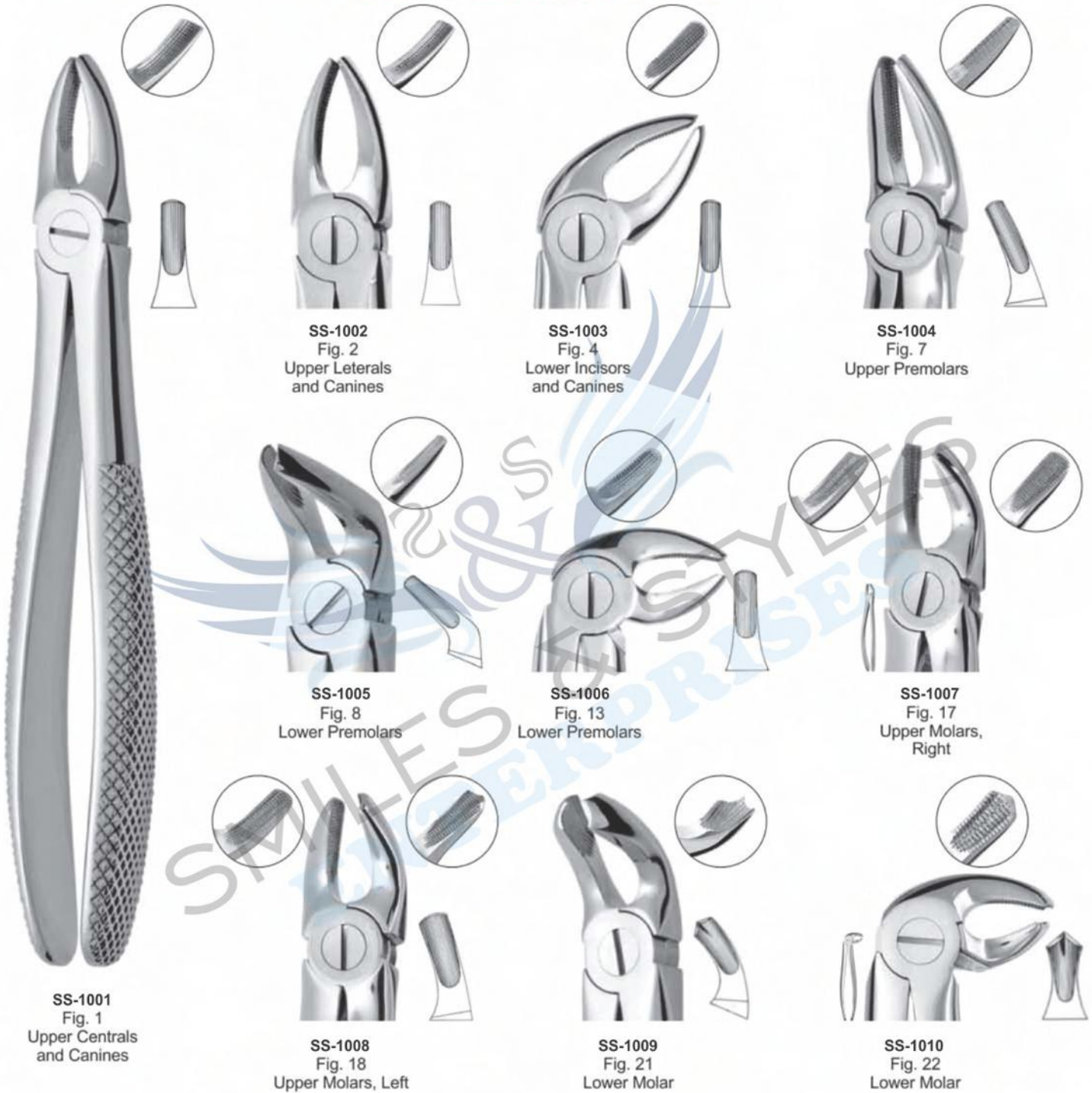

Straight extracting forceps for upper incisors and canines



Straight extracting forceps for upper incisors and canines



Straight extracting forceps for upper incisors and canines

## EXTRACTING FORCEPS (English Pattern)

- Щипцы экстракционные (английская форма)
- Щипці екстракційні (англійська форма)
- Forceps de Extracción (Forme Inglesa)
- استخراج الملقط (نمط اللغة الإنجليزية)
- Daviers (Forme Anglaise)
- Forceps de Extracción (Forme Inglesa)
- Zahnzangen (Englische Form)

Function: To remove teeth from bony socket



SS-1011  
# 18A  
upper molars



SS-1012  
# 19  
upper third molars



SS-1013  
# 20  
lower third molar



SS-1014  
# 24  
lower molar, right



SS-1015  
# 29  
upper roots



SS-1016  
# 30  
Upper Roots



SS-1017  
# 33  
lower roots



SS-1018  
# 33A  
Lower Roots



SS-1019  
# 33M  
Lower roots  
with long beak



SS-1020  
# 46L



SS-1021  
# 51  
Upper Roots



SS-1022  
# 51A  
Upper Roots



Straight extracting forceps for upper incisors and canines



Straight extracting forceps for upper incisors and canines



Straight extracting forceps for upper incisors and canines



## EXTRACTING FORCEPS (English Pattern)

- Щипцы экстракционные (английская форма)
- Щипці екстракційні (англійська форма)
- Forceps de Extracción (Forme Inglesa)
- Daviers (Forme Anglaise)
- Forcets de Extracción (Forme Inglesa)
- Zahnzangen (Englische Form)
- استخراج المنقذ (نمط اللغة الإنجليزية)

Function: To remove teeth from bony socket

### WISDOM EXTRACTING FORCEPS



SS-1023  
Routerier  
(# 22 ½ L)  
lower molars and  
wisdoms, left

SS-1024  
Routerier  
(# 22 ½ R)  
lower molars and  
wisdoms, right



SS-1029  
# 51AL



SS-1025  
Routerier  
(# 33 ½ L)  
lower molar and  
wisdom roots, left

SS-1026  
Routerier  
(# 33 ½ R)  
lower molar and  
wisdom roots, right

*Routerier extracting forceps for lower molars  
and third molars, right*



SS-1030  
# 67  
Upper Thrid Molars



SS-1031  
# 67A  
Upper Thrid Molars



SS-1032  
# 79  
Lower Third Molars



SS-1027  
Fig. 186L  
lower molars

SS-1028  
Fig. 186R  
lower molars



*Angled extracting forceps for upper roots*



## EXTRACTING FORCEPS (English Pattern)

- Щипцы экстракционные (английская форма)
- Daviers (Forme Anglaise)
- Zahnzangen (Englische Form)
- Щипці екстракційні (англійська форма)
- Forceps de Extracción (Forme Inglesa)
- استخراج الملقط (نمط اللغة الإنجليزية)

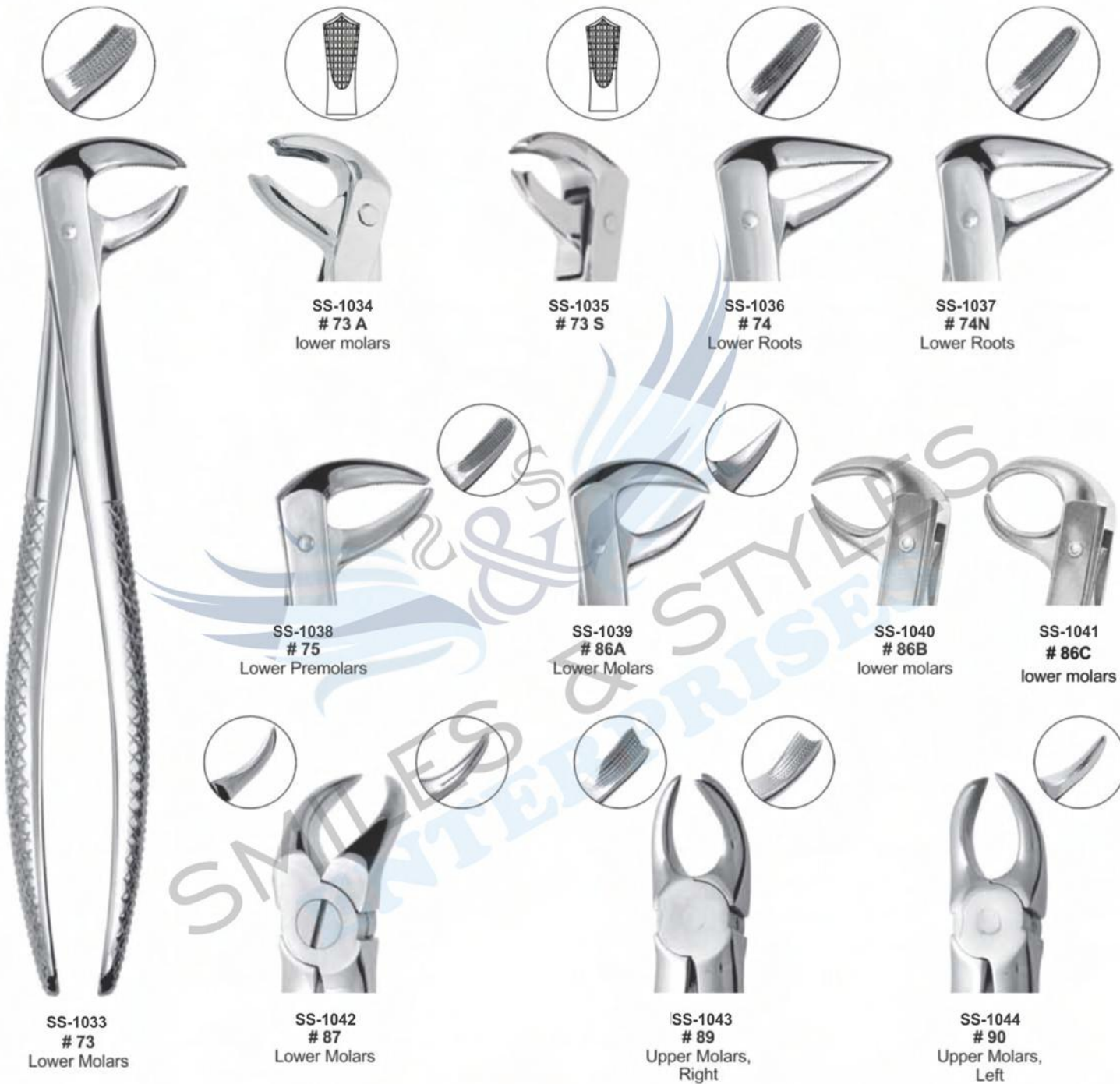

Straight extracting forceps for upper incisors and canines



Straight extracting forceps for upper incisors and canines



Straight extracting forceps for upper incisors and canines

## EXTRACTING FORCEPS (English Pattern)

- Щипцы экстракционные (английская форма)
- Daviers (Forme Anglaise)
- Zahnzangen (Englische Form)
- Щипці екстракційні (англійська форма)
- Forceps de Extracción (Forme Inglesa)
- استخراج المنقذ (نمط اللغة الإنجليزية)

### DE-TRAUMATIC EXTRACTION

Improved tapered beaks for complete root contact. Cross serrations. Deep Gripe Extracting Forceps



- No Fracture
- No Tissue Damage
- Extraction With Easy

Thin Tip



**SS-1045  
# 34**  
Upper incisors and  
premolars  
deep-gripping

Wide Tip



**SS-1046  
# 34A**  
Upper centrals / cains  
deep-gripping

Thin Tip



**SS-1047  
Fig. 35**  
upper permolars  
deep-gripping

Wide Tip



**SS-1048  
# 35A**  
Upper incisors and  
premolars  
deep-gripping

Thin Tip



**SS-1049  
# 36**  
Lower premolars  
deep-gripping

Wide Tip



**SS-1050  
# 36A**  
Lower premolars  
deep-gripping

**SS-1051  
# 336**

lower permolars  
deep-gripping



**SS-1052  
F-7C**  
lower molar



**SS-1053  
# 9**  
Apex Forceps Lower Universal  
Deep Root Pick



**SS-1054  
# 79N**  
Lower third molars  
deep-gripping



**SS-1055  
# 79**  
Lower Thrid Molars



#### Function:

Extraction forceps are used to further loosen teeth by rotational and tilting movements and finally to extract the teeth in combination with a fulcrum.



## EXTRACTING FORCEPS (English Pattern)

- Щипцы экстракционные (английская форма)
- Daviers (Forme Anglaise)
- Zahnzangen (Englische Form)
- Щипці екстракційні (англійська форма)
- Forceps de Extracción (Forme Inglesa)
- استخراج الملقط (نمط اللغة الإنجليزية)

### DEEP ROOT PICK FORCEPS



**SS-1056  
# 146**  
Apex Forceps Lower Root  
Deep Root Pick



**SS-1057  
# 153**  
Apex Forceps Upper Root  
Deep Root Pick



**SS-1058  
# 149**  
Apex Forceps Upper Root  
Deep Root Pick



**SS-1059  
Fig. 44**



**SS-1060  
Fig. 44Z**



**SS-1061  
Fig. 45Z**



**SS-1062  
# 46XL**  
Apex Forceps Lower Root  
Deep Root Pick



**SS-1063  
# 67**  
Upper Third Molars



**SS-1064  
# 67A**  
Upper Third Molars



**SS-1065  
# 67N**  
Lower third molars  
deep-gripping



**SS-1066  
# 331**  
upper roots  
deep-gripping



forceps for upper incisors, premolars and roots





## EXTRACTING FORCEPS (English Pattern)

- Щипцы экстракционные (английская форма)
- Daviers (Forme Anglaise)
- Zahnzangen (Englische Form)

- Щипці екстракційні (англійська форма)
- Forceps de Extracción (Forme Inglesa)
- استخراج المنقط (تمط اللغة الإنجليزية)



Fig. 1  
upper  
laterals  
and canines



**SS-1067**  
Set of 10 Pieces  
Fig. 1  
Fig. 7  
Fig. 13  
Fig. 17  
Fig. 18  
Fig. 22  
Fig. 51A  
Fig. 67  
Fig. 74N  
Fig. 79

Fig. 7  
upper premolars



Fig. 13  
lower premolars



Fig. 17  
upper molars, right



Fig. 18  
upper molars, left



Fig. 22  
lower roots



Fig. 51A  
upper roots



Fig. 67  
upper third molars



Fig. 74N  
lower molar



Fig. 79  
lower third molars



Extracting forceps for upper roots



# EXTRACTING FORCEPS

- Щипцы экстракционные
- Щипці екстракційні
- Daviers
- Forceps de Extracción
- Zahnzangen
- استخراج الملقط

## Pediatric Tooth Extracting Forceps Set



**SS-1068**  
English Pattern Klein #51S  
Pedodontic Upper root



**SS-1069**  
English Pattern Klein #137  
Pedodontic, Upper Incisors Spring handle



**SS-1070**  
English Pattern Klein #5  
Pedodontic Lower Incisors.



**SS-1071**  
English Pattern Klein #139  
Pedodontic Upper Premolars

### Baby Tooth Extraction Forceps



**SS-1072**  
Fig. # 01 to 07  
Set of 7 Pieces



**SS-1073**  
English Pattern Klein #7  
Pedodontic Lower Roots,



**SS-1074**  
English Pattern Klein #3  
Pedodontic Upper Molars Universal

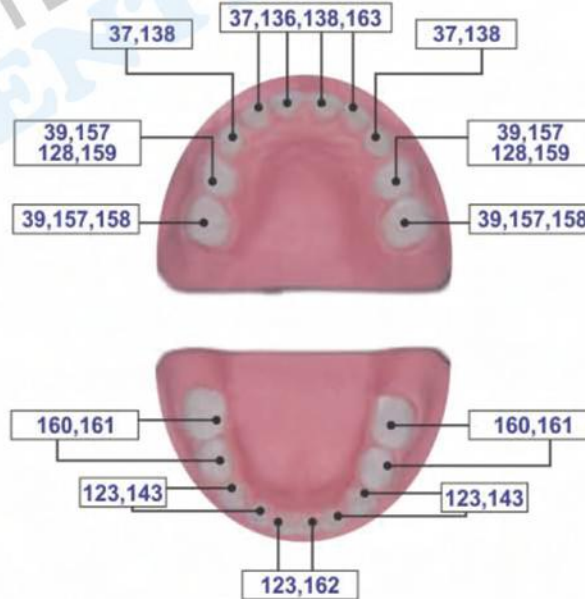

**SS-1075**  
English Pattern Klein #6  
Pedodontic Lower Molars, Spring Handle



# ROOT FRAGMENT FORCEPS



Witzel  
SS-1076  
170mm  
Upper roots, Universal



Witzel  
SS-1077  
165mm  
Lower roots, Universal



SS-1078  
#400(300)  
165mm  
Upper roots, Universal



SS-1079  
#401(301)  
160mm  
Lower roots, Universal



SS-1080  
Witzel Forceps With Gold  
Set of 3 Pcs



SS-1081  
Witzel Forceps With Hole And Screw Pattern  
Set of 3 Pcs



SS-1082  
Witzel Forceps With Anatomical Handle  
Set of 3 Pcs



SS-1083  
#401(301)  
160mm  
Lower roots, Universal



SS-1084  
#401(301)  
160mm  
Lower roots, Universal



SS-1085  
#401(301)  
160mm  
Lower roots, Universal



SS-1086  
#400(300)  
165mm  
Upper roots, Universal



SS-1087  
#400(300)  
165mm  
Upper roots, Universal



SS-1088  
#400(300)  
165mm  
Upper roots, Universal



Witzel  
SS-1089  
165mm  
Lower roots, Universal



Witzel  
SS-1090  
165mm  
Lower roots, Universal



Witzel  
SS-1091  
165mm  
Lower roots, Universal



## ROOTS SPLINTER FORCEPS

- Щипцы для удаления корневых осколков
- Pincas Fragments
- Wurzelsplitterzangen
- Щипці для видалення корневих осколків
- Pinzas Para Fragmentos
- جذور منشقة المنقط



SS-1092  
Splinter Forceps  
15.5cm



Stieglitz Root Splinter Forceps



SS-1093  
Splinter Forceps  
15.5cm 45°



SS-1094  
Stieglitz  
Root Fragments



SS-1095  
Stieglitz  
Root Fragments



SS-1096  
Stieglitz Splinter Forceps  
140mm 90°



SS-1097  
Stieglitz Splinter Forceps  
140mm Straight

## ROOT FRAGMENT FORCEPS

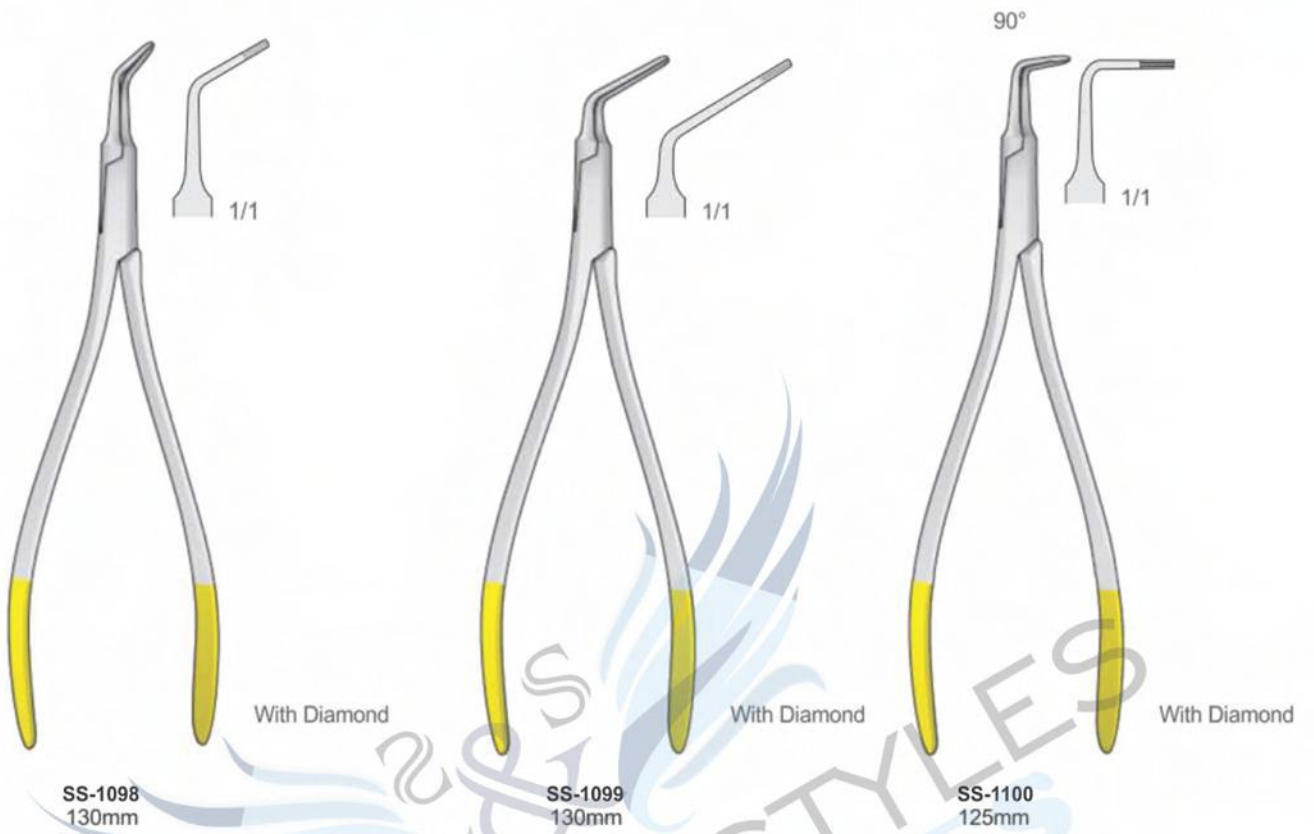

## EXTRACTING FORCEPS (American Pattern)

- Щипцы экстракционные (американская форма)
- Dавiers - forme américaine
- Fórceps de extracción - forma americana
- Щипці екстракційні (американська форма)
- Pinzere per estrazione - forma americana
- استخراج الملقط (النمط الأمريكي)

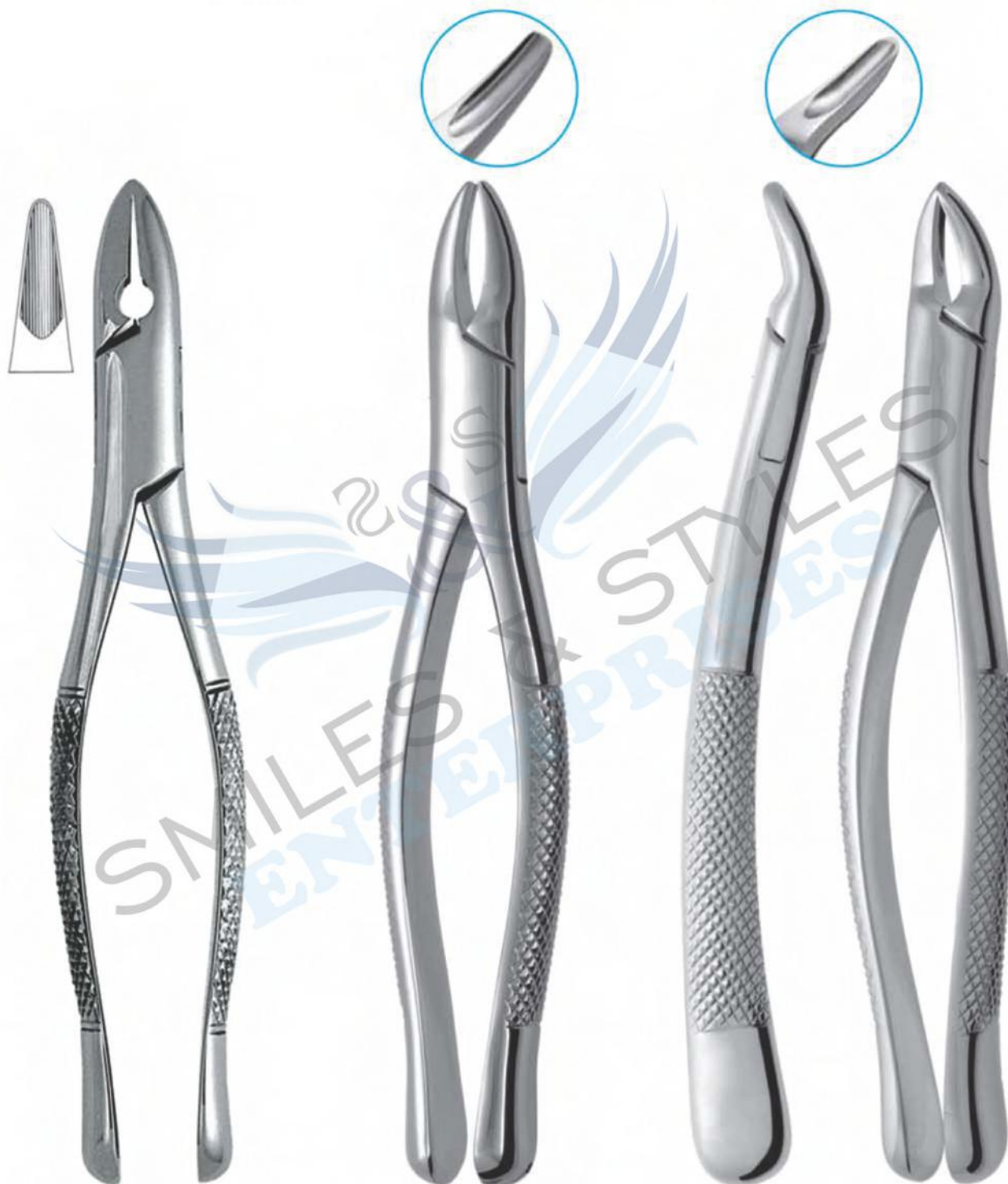

SS-1104  
# 1STD  
Winter  
upper centrals and canines

SS-1105  
Fig. 1  
upper incisors  
and roots

SS-1106  
Cryer  
Fig. 150



## EXTRACTING FORCEPS (American Pattern)

- Щипцы экстракционные (американская форма)
- Щипці екстракційні (американська форма)
- Daviers - forme américaine
- Pinzeper per estrazione - forma americana
- Fórceps de extracción - forma americana
- استخراج المنقط (النمط الأمريكي)



SS-1108  
Fig. 62  
incisors, premolars,  
deciduous teeth



SS-1109  
# 10S  
upper roots



SS-1110  
# 17  
lower molars



SS-1111  
Harris  
Fig. 18R



SS-1112  
Harris  
Fig. 18L



SS-1107  
Fig. 150A  
Cryer  
upper incisors, premolars, roots

## EXTRACTING FORCEPS (American Pattern)

- Щипцы экстракционные (американская форма)
- Dавiers - forme américane
- Fórceps de extracción - forma americana
- Щипці екстракційні (американська форма)
- Pinzeper per estrazione - forma americana
- استخراج الملقط (النمط الأمريكي)

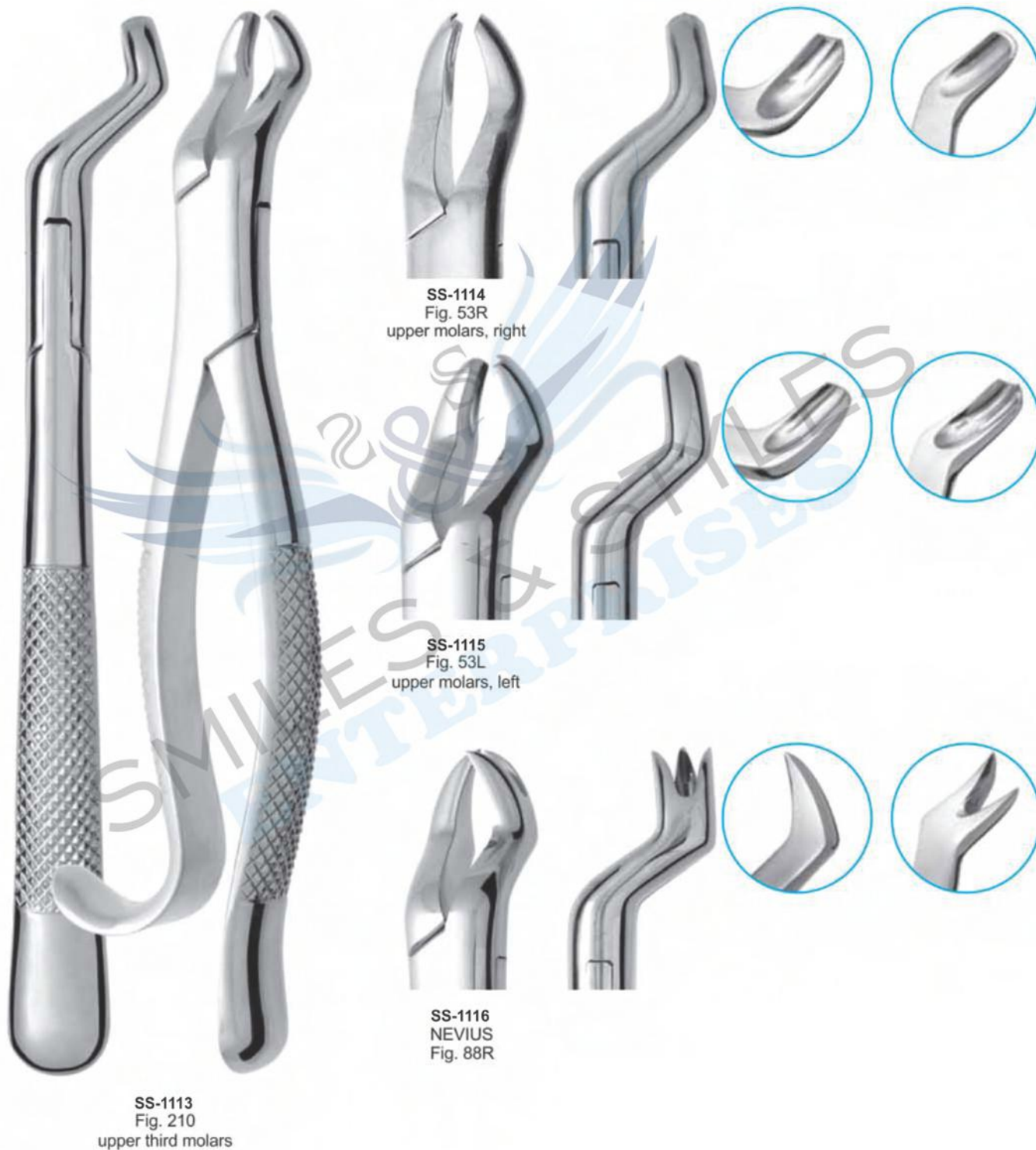



## EXTRACTING FORCEPS (American Pattern)

- Щипцы экстракционные (американская форма)
- Щипці екстракційні (американська форма)
- Daviers - forme américaine
- Pinzeper per estrazione - forma americana
- Fórceps de extracción - forma americana
- استخراج المنقط (النمط الأمريكي)



SS-1117  
Fig. 24  
upper molars



SS-1118  
# 210S  
upper third molars



SS-1119  
# 210H  
upper third molars



SS-1120  
# 286  
Upper Roots,  
Premolars, Incisors



SS-1121  
# 99C  
Kells  
upper incisors,  
canines, premolars



SS-1122  
# 222  
lower third molars



SS-1123  
# 286  
Lower Molar

## EXTRACTING FORCEPS (American Pattern)

- Щипцы экстракционные (американская форма)
- Dавiers - forme américane
- Fórceps de extracción - forma americana
- Щипці екстракційні (американська форма)
- Pinzoper per estrazione - forma americana
- استخراج الملقط (النمط الأمريكي)



SS-1124  
Nevius  
Fig. 88L  
upper molars, left



SS-1125  
Fig. 65  
upper incisors  
and roots



SS-1126  
Parmly Fig. 32A  
upper premolars  
and roots



SS-1127  
Parmly Fig. 32  
upper premolars  
and molars





## EXTRACTING FORCEPS (American Pattern)

- Щипцы экстракционные (американская форма)
- Щипці екстракційні (американська форма)
- Daviers - forme américaine
- Pinzeper per estrazione - forma americana
- Fórceps de extracción - forma americana
- استخراج المنقط (النمط الأمريكي)

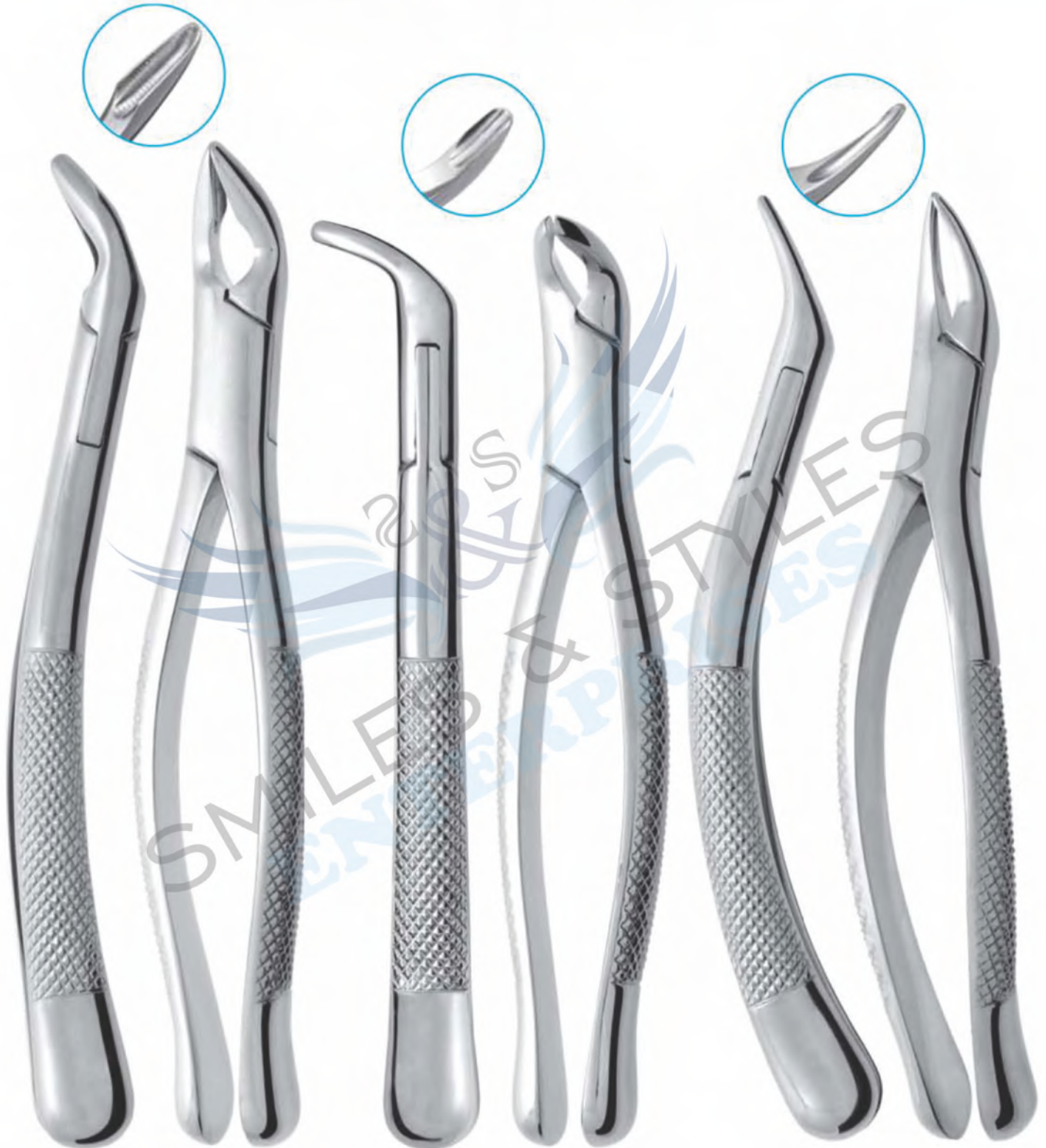

SS-1128  
COHEN  
universal

SS-1129  
Fig. 203  
lower incisors  
and roots

SS-1130  
Tomes Fig. 69  
upper and lower  
roots

## EXTRACTING FORCEPS (American Pattern)

- Щипцы экстракционные (американская форма)
- Dавiers - forme américaine
- Fórceps de extracción - forma americana
- Щипці екстракційні (американська форма)
- Pinzere per estrazione - forma americana
- استخراج الملقط (النمط الأمريكي)



SS-1131  
Fig. 23  
lower molars

SS-1132  
Fig. 16  
lower molars

SS-1133  
Physic Fig. 5  
lower third molars

SS-1134  
Harris Fig. 15  
lower molars

SS-1135  
Fig. 103



## EXTRACTING FORCEPS (American Pattern)

- Щипцы экстракционные (американская форма)
- Щипці екстракційні (американська форма)
- Daviers - forme américaine
- Pinzeper per estrazione - forma americana
- Fórceps de extracción - forma americana
- استخراج المنقط (النمط الأمريكي)



SS-1136  
Hull  
Fig. 101  
Deciduous teeth

SS-1137  
Cryer  
Fig. 150S  
upper teeth,  
for children

SS-1138  
Fig. 150 AS

## EXTRACTING FORCEPS (American Pattern)

- Щипцы экстракционные (американская форма)
- Dавiers - forme américane
- Fórceps de extracción - forma americana
- Щипці екстракційні (американська форма)
- Pinzoper per estrazione - forma americana
- استخراج الملقط (النمط الأمريكي)

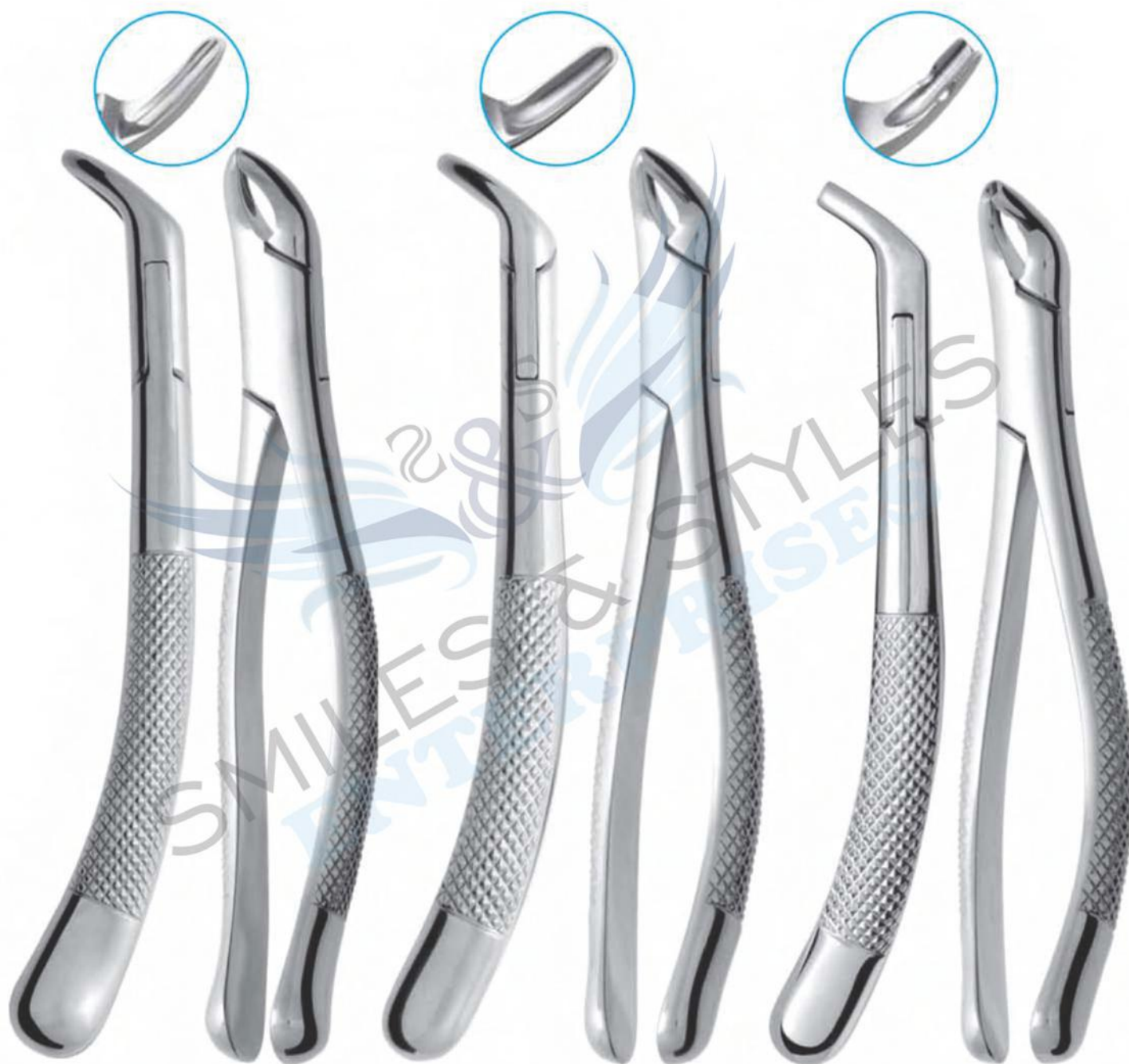

SS-1139  
Cryer  
Fig. 151  
lower teeth,  
for children

SS-1140  
Fig. 151 S  
lower incisors,  
premolars, roots

SS-1141  
Fig. 151 AS



## EXTRACTING FORCEPS (American Pattern)

- Щипцы экстракционные (американская форма)
- Щипці екстракційні (американська форма)
- Daviers - forme américaine
- Pinzeper per estrazione - forma americana
- Fórceps de extracción - forma americana
- استخراج المنقط (النمط الأمريكي)



SS-1142  
# 16S  
lower molars for children



SS-1143  
# 17S  
lower molars

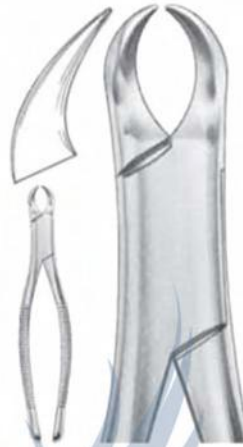

SS-1144  
# 23 S  
Lower molars

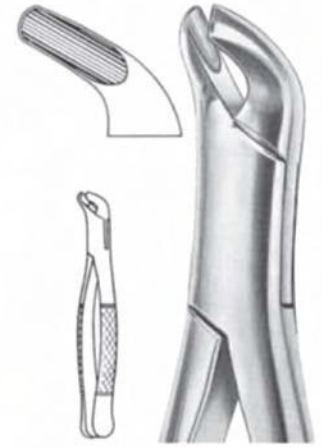

SS-1145  
# 27  
lower molars



SS-1146  
# 18LS  
upper molars left



SS-1147  
# 18RS  
upper molars right



SS-1148  
# 85 Tomas  
lower canines, premolars and molars



SS-1149  
# 85A Tomas  
lower canines, premolars and molars



SS-1150  
# 69S  
upper and lower roots



SS-1151  
# 99A Kells  
upper incisors, canines, premolars



SS-1152  
# 217  
lower molars

## EXTRACTING FORCEPS (American Pattern)

- Щипцы экстракционные (американская форма)
- Dавiers - forme americane
- Fórceps de extracción - forma americana
- Щипці екстракційні (американська форма)
- Pinzeper per estrazione - forma americana
- استخراج الملقط (النمط الأمريكي)



SS-1153  
#10 SK  
Upper Molars Sup



SS-1154  
#17 SK Universal  
Lower Molars



SS-1155  
#23 SK Universal  
Upper Molars



SS-1156  
#69 SK Tomas  
upper and lower roots



SS-1157  
#99 SK  
upper incisors,  
canines, premolars



SS-1158  
#150 SK  
upper incisors,  
premolars, roots



SS-1159  
#151 SK  
lower incisors,  
premolars, roots



SS-1160  
#222 SK  
lower third molars



## EXTRACTING FORCEPS (American Pattern)

- Щипцы экстракционные (американская форма)
- Щипцы екстракційні (американська форма)
- Daviers - forme américaine
- Pinzeper per estrazione - forma americana
- Fórceps de extracción - forma americana
- استخراج المنقط (النمط الأمريكي)



SS-1161  
Fig. 1  
Upper Anterior

SS-1162  
Lower Molar  
Fig. 23 Cow Horn



SS-1163  
Fig. 74  
Lower Anterior



SS-1164  
Fig. 88L  
Upper Molar Left



SS-1165  
Fig. 88R  
Upper Molar Right



SS-1166  
Fig. 74  
Lower Anterior



SS-1167  
Fig. 106  
Lower Incisors



SS-1168  
Fig. 174  
Extra Narrow  
Lower Anterior  
Apical Retention  
Forceps



SS-1169  
Fig. 859  
Lower Molars  
Roots



## EXTRACTING FORCEPS (American Pattern)

- Щипцы экстракционные (американская форма)
- Щипці екстракційні (американська форма)
- Pinzeper per estrazione - forma americana
- Pinzeper per estrazione - forma americana
- Fórceps de extracción - forma americana
- استخراج الملقط (النمط الأمريكي)

### Carbide Diamond Coated Point



**SS-1171**  
151 T.C.  
Carbide Serrated Beak  
Lower Incisors, Cuspids,  
Bicuspid & Roots, Universal

**SS-1172**  
1STD T.C.  
Carbide Serrated Beak  
Upper Incisors, Cuspids,

**SS-1173**  
17 T.C.  
Carbide Serrated Beak  
1st & 2nd Lower Molars,  
Universal



**SS-1174**  
53L T.C.  
Carbide Serrated Beak  
1st & 2nd Upper Molars,  
Left

**SS-1175**  
53R T.C.  
Carbide Serrated Beak  
1st & 2nd Upper Molars,  
Right

**SS-1176**  
65 T.C.  
Carbide Serrated Beak  
Upper Incisors, Roots &  
Fragments



**SS-1170**  
150 T.C.  
Carbide Serrated Beak  
Upper Incisors, Cuspids,  
Bicuspid & Roots,  
Universal

**SS-1177**  
69 T.C.  
Carbide Serrated Beak  
Upper & Lower Fragments  
And Roots

**SS-1178**  
150S T.C. Pedro forcep  
Carbide Serrated Beak  
Pedo, Upper Primary Teeth  
and Roots, Universal

**SS-1179**  
151S T.C. Pedro forcep  
Carbide Serrated Beak  
Pedo, Lower Primary Teeth  
and Roots, Universal



## BONE ROUNGER

- Костные кусачки
- Hohlmeißelzangen
- Pincés-gouges
- Кусачки для кісток
- Pinzas-gubias
- روتجورس العظام



SS-1180  
Blumenthal  
15cm



SS-1181  
Blumenthal  
15cm



SS-1182  
Blumenthal  
15cm



SS-1183  
Friedman  
14cm



SS-1184  
Friedman  
14.5cm



SS-1185  
Micro-Friedman  
14cm



SS-1186  
Micro-Friedman  
15cm



SS-1187  
Micro-Friedman  
16cm



SS-1188  
Kleinert-Kutz  
18.5cm



SS-1189  
Beyer  
18.5cm



SS-1190  
Mead 1A  
18.5cm



SS-1191  
Luer  
18.5cm

## EXTRACTING FORCEPS (English Pattern)

- Щипцы экстракционные (английская форма)
- Daviers (Forme Anglaise)
- Zahnzangen (Englische Form)
- Щипці екстракційні (англійська форма)
- Forceps de Extracción (Forme Inglesa)
- استخراج الملقط (نمط اللغة الإنجليزية)

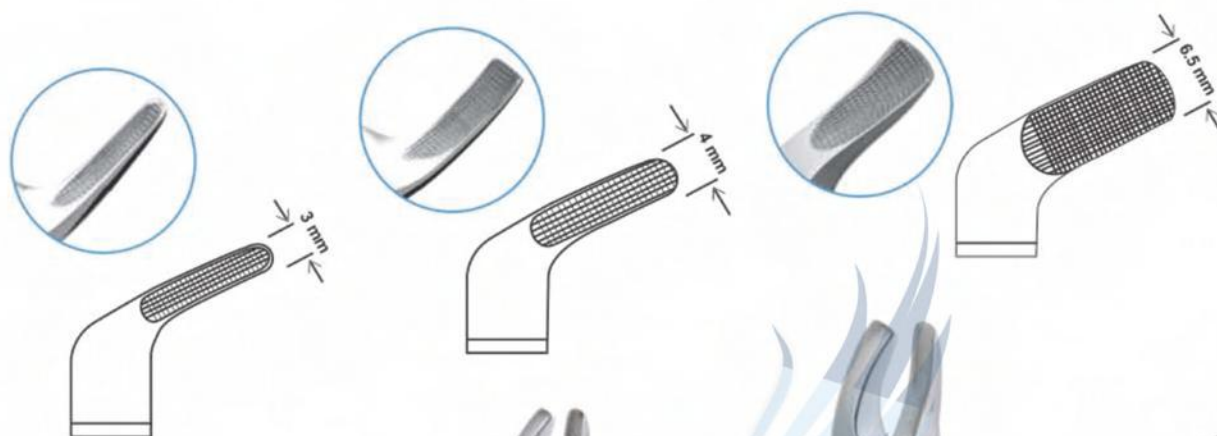

SS-1192  
Meissner  
Extracting Forceps



SS-1193  
Meissner  
Extracting Forceps



SS-1194  
Meissner  
Extracting Forceps



SS-1195  
Comellas Forceps  
Anatomical Handle



# DENTAL SYRINGES

- Шприцы стоматологические карпульные
- Шприці стоматологічні карпульні
- Seringues à usage dentaire
- Jeringas dentales
- Dentalspritzen
- المحاقن الأسنان



SS-1196 1.8ml  
SS-1197 2.2ml



SS-1198 1.8ml  
SS-1199 2.2ml



SS-1200 1.8ml  
SS-1201 2.2ml



SS-1202 1.8ml  
SS-1203 2.2ml



SS-1204 1.8ml  
SS-1205 2.2ml



Hi1206 1.8ml  
SS-1207 2.2ml



SS-1208  
# 1001  
Intraligamental  
Anesthesia  
Syringe in  
Black Colour



SS-1209 1.8ml  
SS-1210 2.2ml  
Angled



SS-1211  
Aluminium - Dark 1.8 ml

- |   |   |  |                                       |
|---|---|--|---------------------------------------|
|   |   |  |                                       |
| SS-1212<br>Aluminium -<br>Silver 1.8 ml | SS-1213<br>Aluminium -<br>Orange 1.8 ml | SS-1214<br>Aluminium -<br>Green 1.8 ml | SS-1215<br>Aluminium -<br>Blue 1.8 ml |



Type C  
SS-1216 1,8ml  
SS-1217 2,2ml



Type C  
SS-1218 1,8ml  
SS-1219 2,2ml



2-Ring  
SS-1220 1,8ml  
SS-1221 2,2ml



Aspirating Syringe  
SS-1222 1,8mm  
SS-1223 2,2mm



Cartridge Syringe  
SS-1224 1,8mm  
SS-1225 2,2mm



Cartridge Syringe  
SS-1226 1,8mm  
SS-1227 2,2mm



Cartridge Syringe  
SS-1228 1,8mm  
SS-1229 2,2mm

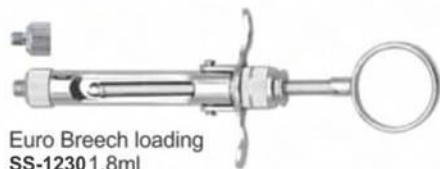

Euro Breech loading  
SS-1230 1,8ml  
SS-1231 2,2ml

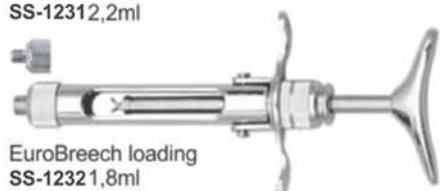

EuroBreech loading  
SS-1232 1,8ml  
SS-1233 2,2ml



Manual Aspirating Syringe  
SS-1234 1,8ml  
SS-1235 2,2ml



Quatro  
SS-1236 1,8ml  
SS-1237 2,2ml



Trio  
SS-1238 1,8ml  
SS-1239 2,2ml

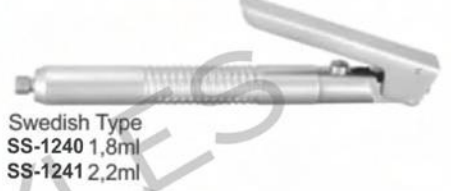

Swedish Type  
SS-1240 1,8ml  
SS-1241 2,2ml



Ject Ultima  
SS-1242 1,8ml  
SS-1243 2,2ml  
Injects 0,05 ml with every click Supplied with  
angled and straight tubes



Ject angled  
SS-1244 1,8ml  
SS-1245 2,2ml



Ject straight  
SS-1246 1,8ml  
SS-1247 2,2ml



Disc System  
SS-1248 1,8ml  
SS-1249 2,2ml



Disc System  
SS-1250 1,8ml

# EXTRACTING FORCEPS SET

Извлечение щипцов  
Ensemble de pinces d'extraction  
• Zange sammeln

• Витягуючий комплект щипців  
• Extracción del conjunto de fórceps  
• استخراج ملقط مجموعة



**SS-1251**  
Extracting Forceps  
Set of 10 Pieces  
Extracting Forceps Fig. 2  
Extracting Forceps Fig. 7  
Extracting Forceps Fig. 13  
Extracting Forceps Fig. 17  
Extracting Forceps Fig. 18  
Extracting Forceps Fig. 22  
Extracting Forceps Fig. 33  
Extracting Forceps Fig. 51A  
Extracting Forceps Fig. 67A  
Extracting Forceps Fig. 79



**SS-1252**  
Extracting Forceps  
Set of 10 Pieces  
Extracting Forceps Fig. 2  
Extracting Forceps Fig. 7  
Extracting Forceps Fig. 13  
Extracting Forceps Fig. 17  
Extracting Forceps Fig. 18  
Extracting Forceps Fig. 22  
Extracting Forceps Fig. 33  
Extracting Forceps Fig. 51A  
Extracting Forceps Fig. 67A  
Extracting Forceps Fig. 79



**SS-1253**  
Extracting Forceps  
Set of 13 Pieces  
Extracting Forceps Fig. 2  
Extracting Forceps Fig. 7  
Extracting Forceps Fig. 13  
Extracting Forceps Fig. 17  
Extracting Forceps Fig. 18  
Extracting Forceps Fig. 22  
Extracting Forceps Fig. 33  
Extracting Forceps Fig. 51A  
Extracting Forceps Fig. 67A  
Extracting Forceps Fig. 79  
Extracting Forceps Fig. 86C  
Extracting Forceps Fig. 89  
Extracting Forceps Fig. 90



**SS-1254**  
Extracting Forceps Children Pattern  
Set of 10 Pieces  
Extracting Forceps Fig. 13S  
Extracting Forceps Fig. 22S  
Extracting Forceps Fig. 30S  
Extracting Forceps Fig. 33S  
Extracting Forceps Fig. 37  
Extracting Forceps Fig. 38  
Extracting Forceps Fig. 39  
Extracting Forceps Fig. 39L  
Extracting Forceps Fig. 39R  
Extracting Forceps Fig. 51S



**SS-1255**  
Extracting Forceps English adult Adult  
Set of 10 Pcs



**SS-1256**  
Extracting Forceps American Adult  
Set of 10 Pcs



**SS-1257**  
Extracting Forceps American Adult  
Set of 8 Pcs



**SS-1258**  
Extracting Forceps Pedro  
Set of 7 Pcs



## ROOT ELEVATOR

### FUNCTION OF ROOT ELEVATORS IN SURGERY

To Loosen Tooth or Root From Bony Socket Prior to Placement of The Extraction Forceps.

HANDLES FOR ROOT ELEVATORS POINTS A, B, C, D, E, F, G, H



# ROOT ELEVATOR

- Элеватор корневой экстракционный
- Elévateurs à racines
- Wurzelheber
- Elevator corneviu extracțiunii
- Elevadores para raices
- المصاعد الجذر

## Function of Root Elevators:

To loosen tooth or root from bony socket prior to placement of the extraction forceps.

### Apexo Root Elevators



### Luxator Root Elevators

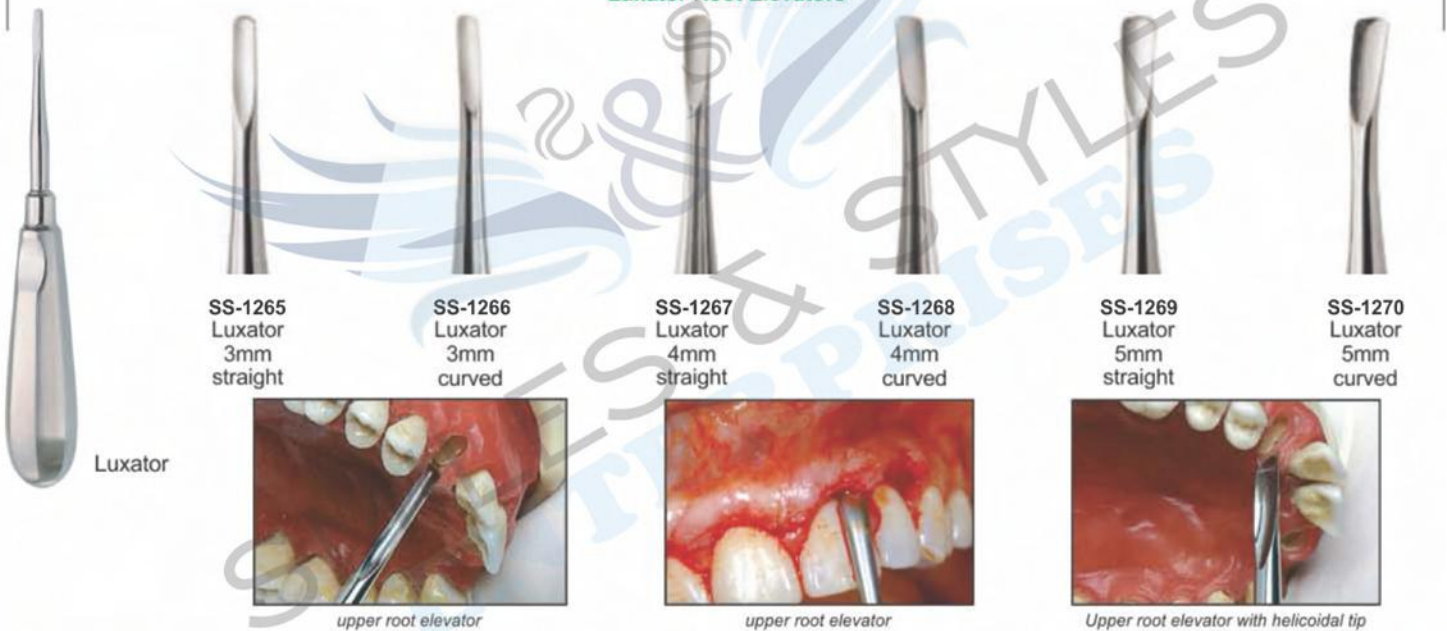

### Bein Root Elevators

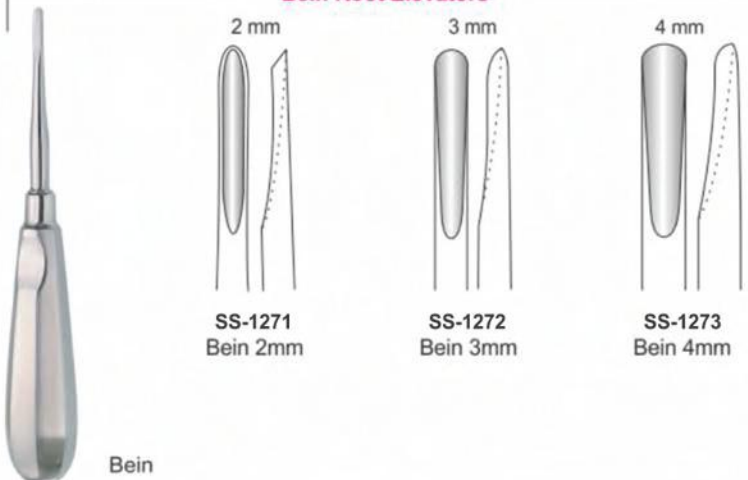

### Seldin Root Elevators

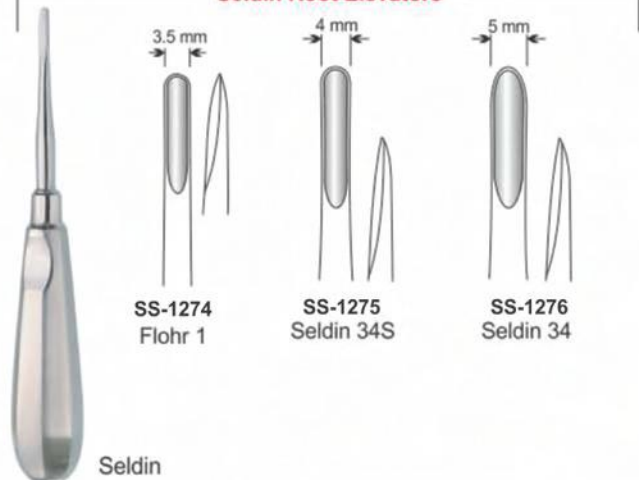



## ROOT ELEVATOR

- Элеватор корневой экстракционный
- Elévateurs à racines
- Wurzelheber
- Слеватор корневий экстракційний
- Elevadores para raices
- المصاعد الجذر

**FUNCTION:** To loosen tooth or root from bony socket prior to placement of the extraction forceps.

### Laxutor Root Elevators



SS-1277  
Laxutor  
1.5mm  
Str.



SS-1278  
Laxutor  
2mm  
Str.



SS-1279  
Laxutor  
3mm  
Str.



SS-1280  
Laxutor  
5mm  
Str.



SS-1281  
Laxutor  
3mm  
Cvd.



SS-1282  
Laxutor  
5mm  
Cvd.



SS-1283  
Laxutor  
3mm  
Upper Angle



SS-1284  
Laxutor  
3mm  
Double Angle



SS-1285  
Laxutor  
3mm  
Str.



SS-1286  
Laxutor  
5mm  
Str.



# ROOT ELEVATOR

- Элеватор корневой экстракционный
- Elévateurs à racines
- Wurzelheber
- Слеватор корневий экстракційний
- Elevadores para raices
- المصاعد الجذر

## Laxutor Root Elevators

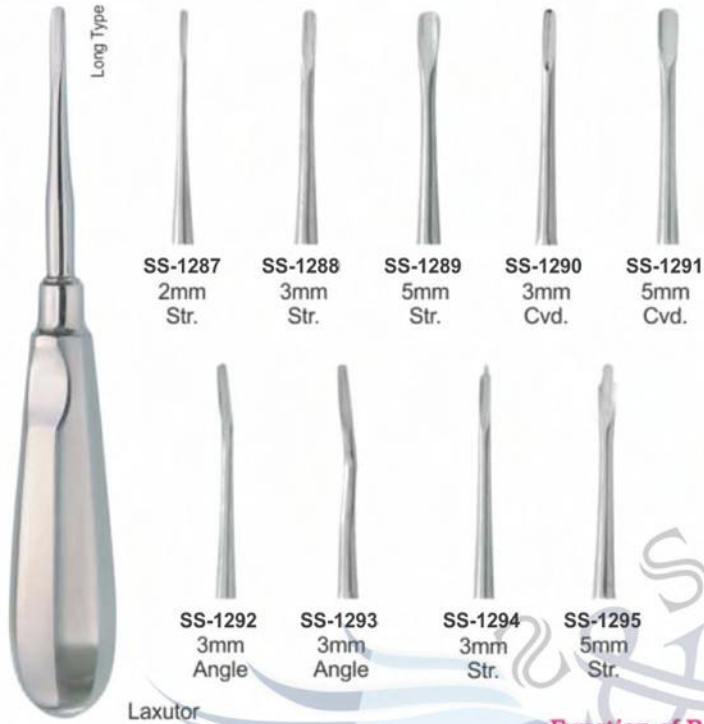

lower roots elevator



Upper root elevator with helicoidal tip

## Luxator Roots Elevator



SS-1296 Luxator Straight

SS-1297 Luxator Curved

### Function of Root Elevators:

To loosen tooth or root from bony socket prior to placement of the extraction forceps.

## Apical Root Elevators

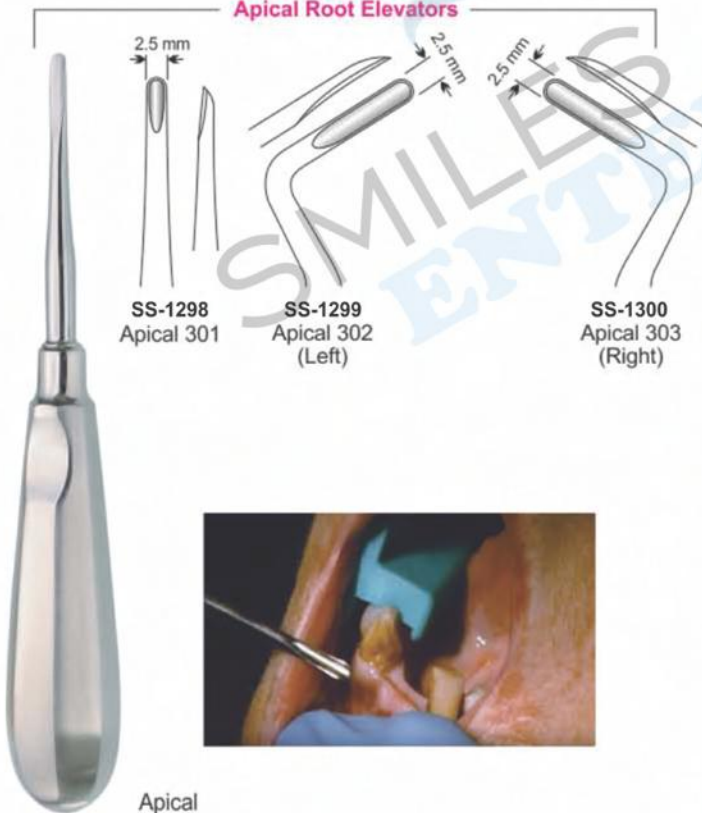

Apical

## Apical Root Elevators

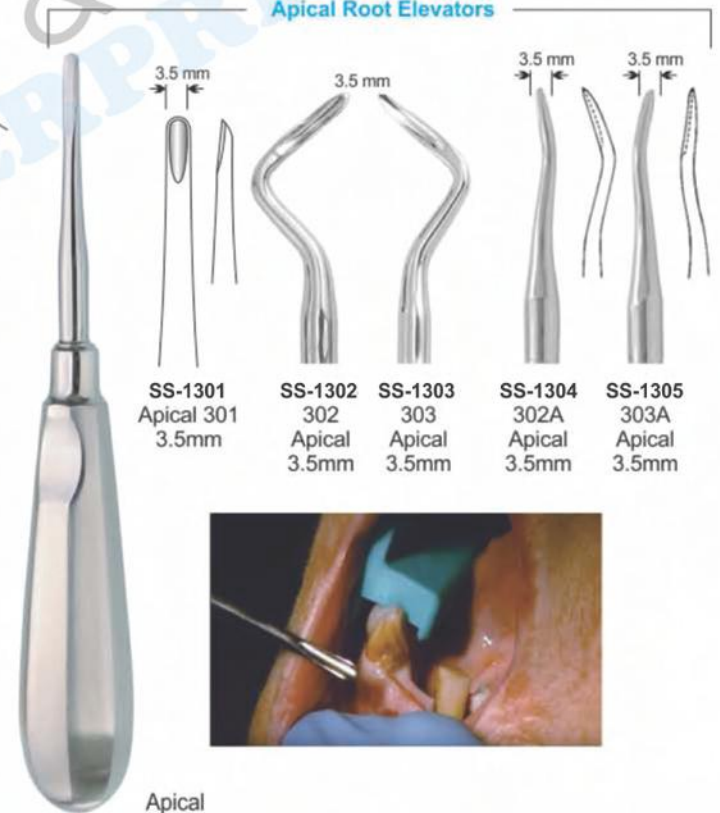

Apical



# ROOT ELEVATOR

- Элеватор корневой экстракционный
- Elévateurs à racines
- Wurzelheber
- Слеватор корневий экстракційний
- Elevadores para raices
- المصاعد الجذر

**FUNCTION:** To Loosen Tooth or Root From Bony Socket Prior to Placement of The Extraction Forceps.

## Cryer Root Elevators

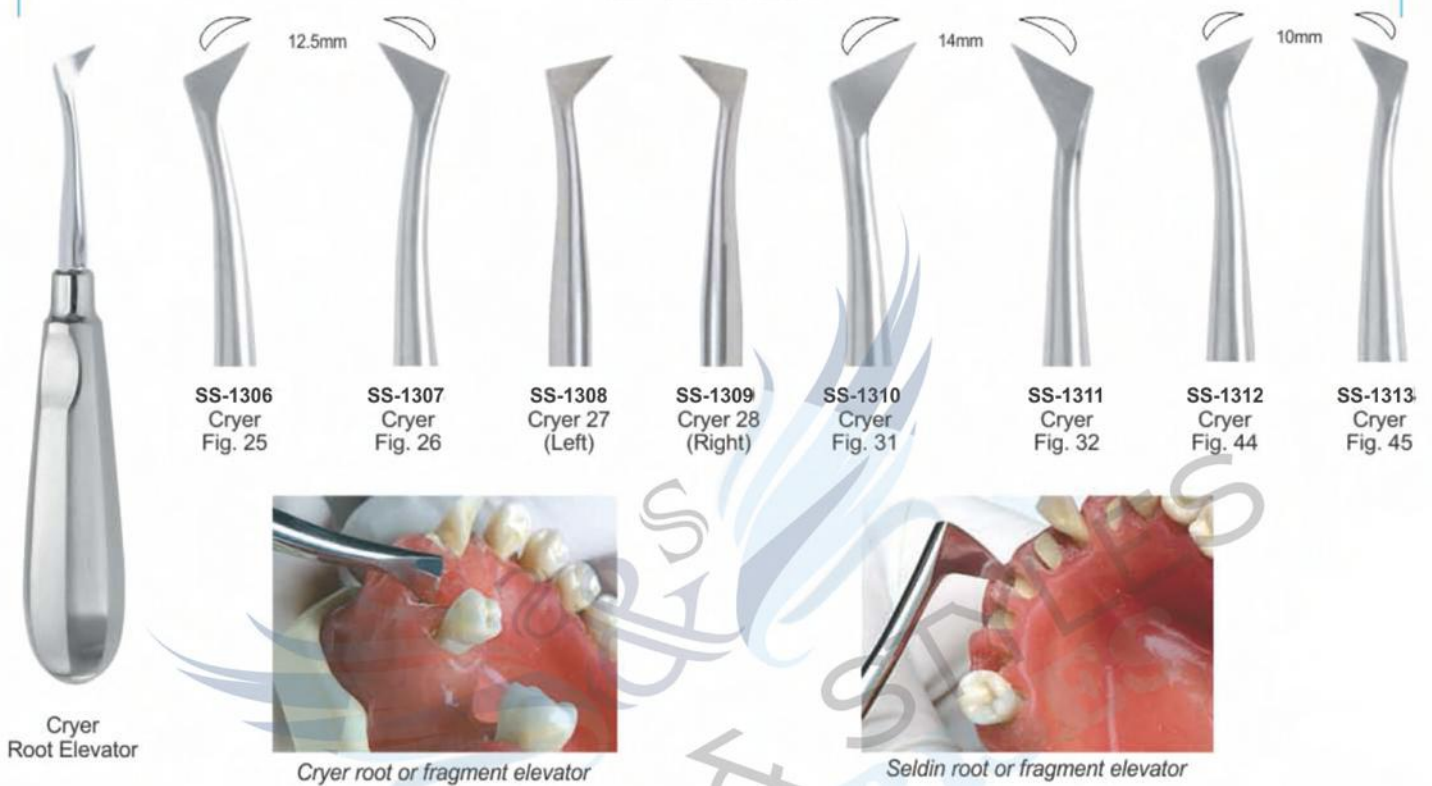

## Seldin Root Elevators

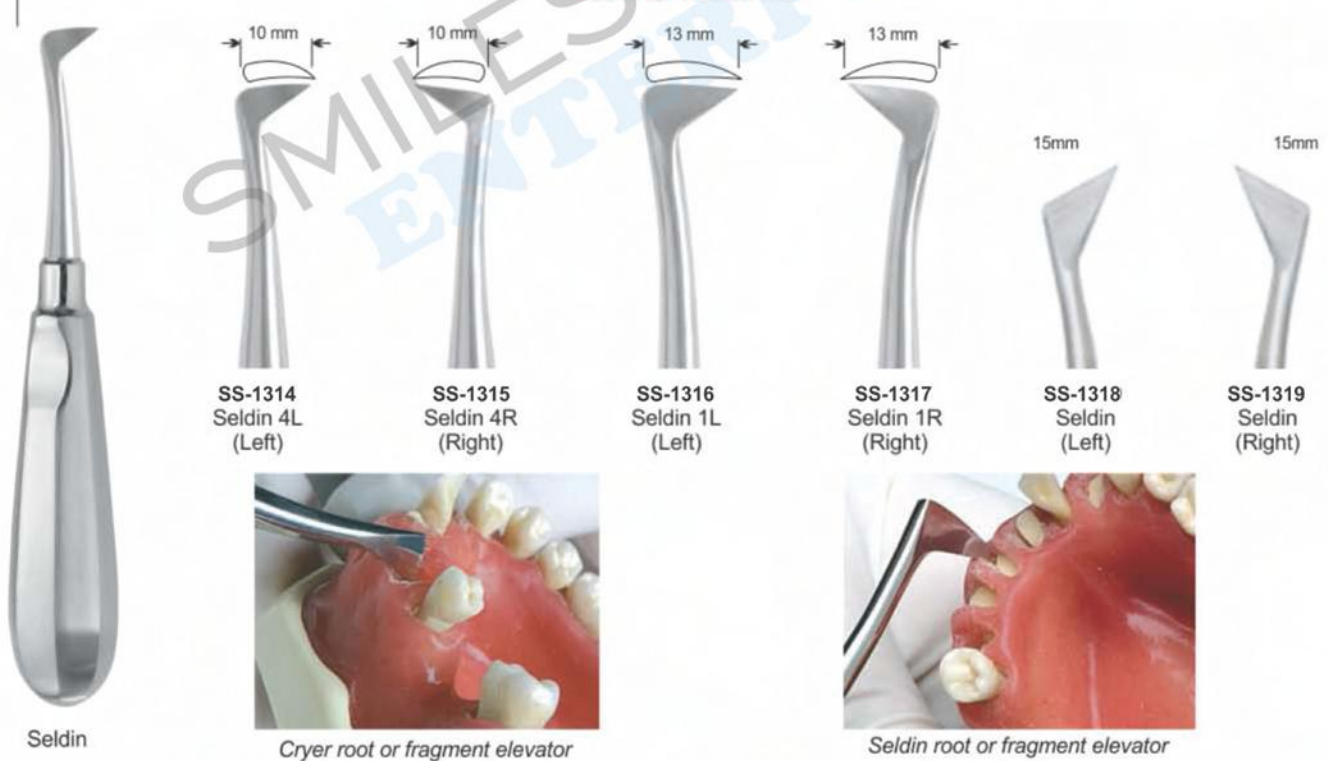

# ROOT ELEVATOR

- Элеватор корневой экстракционный
- Elévateurs à racines
- Wurzelheber
- Слеватор корневий экстракційний
- Elevadores para raices
- المصاعد الجذر

**FUNCTION:** To Loosen Tooth or Root From Bony Socket Prior to Placement of The Extraction Forceps.

## Apical Root Elevators

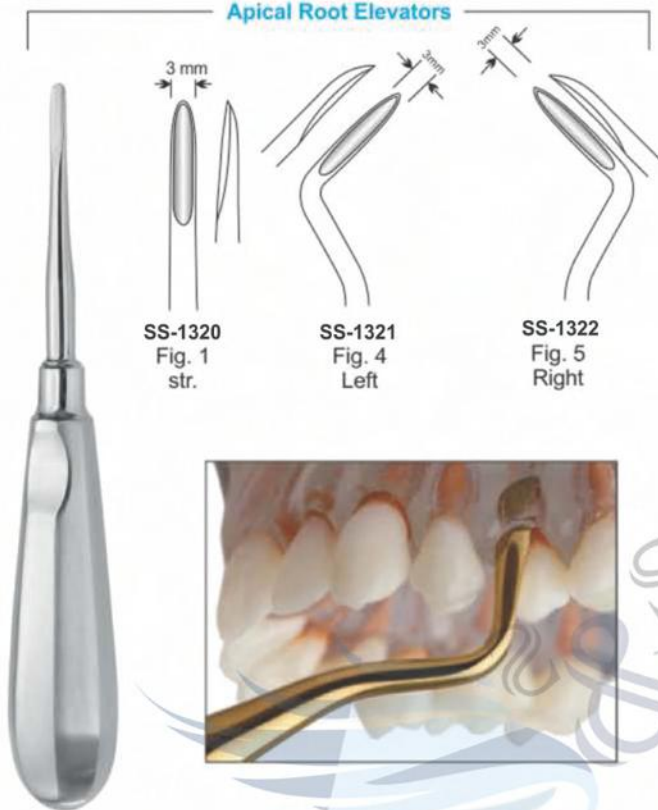

## Apical Root Elevators

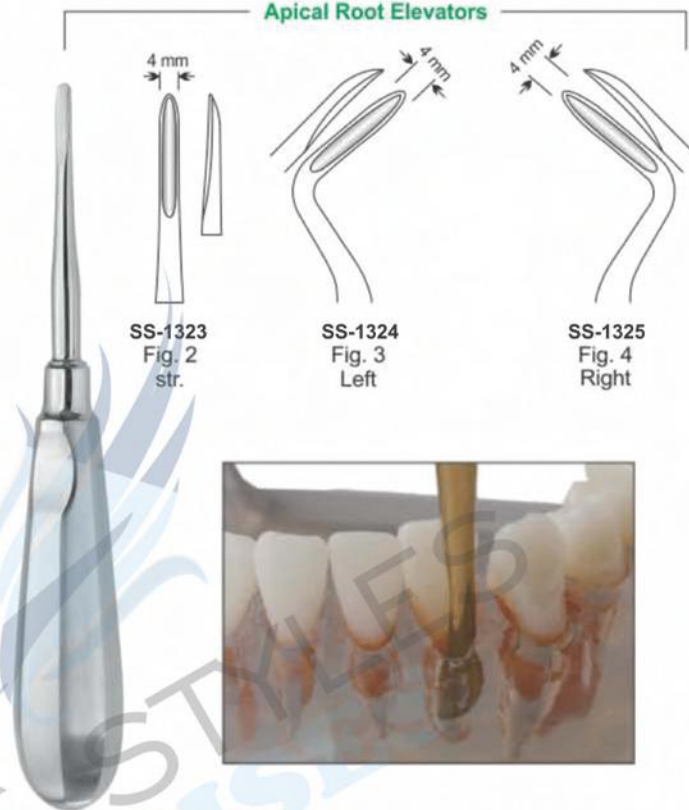

## Flohr Root Elevators



## Heidbrink Root Elevators

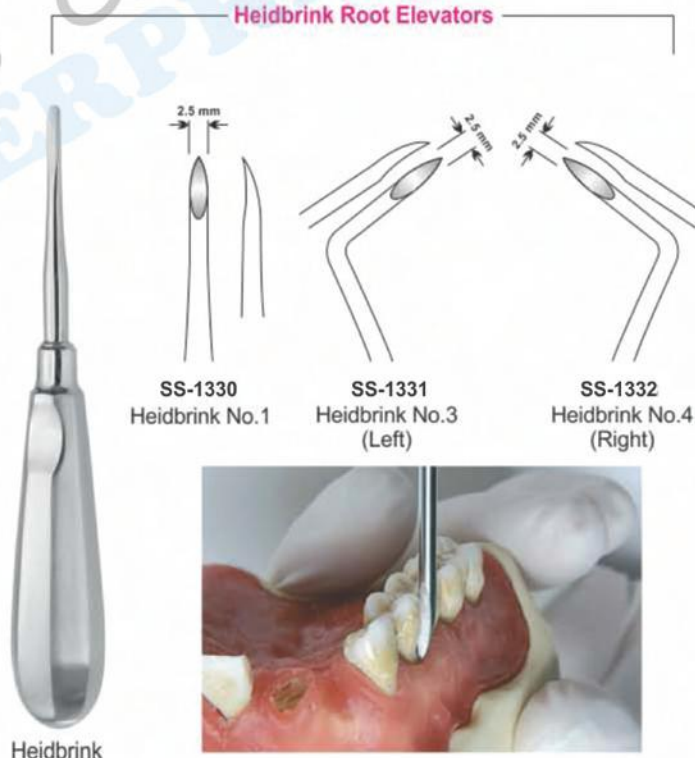



# ROOT ELEVATOR

- Элеватор корневой экстракционный
- Elévateurs à racines
- Wurzelheber
- Слеватор корневий экстракційний
- Elevadores para raices
- المصاعد الجذر

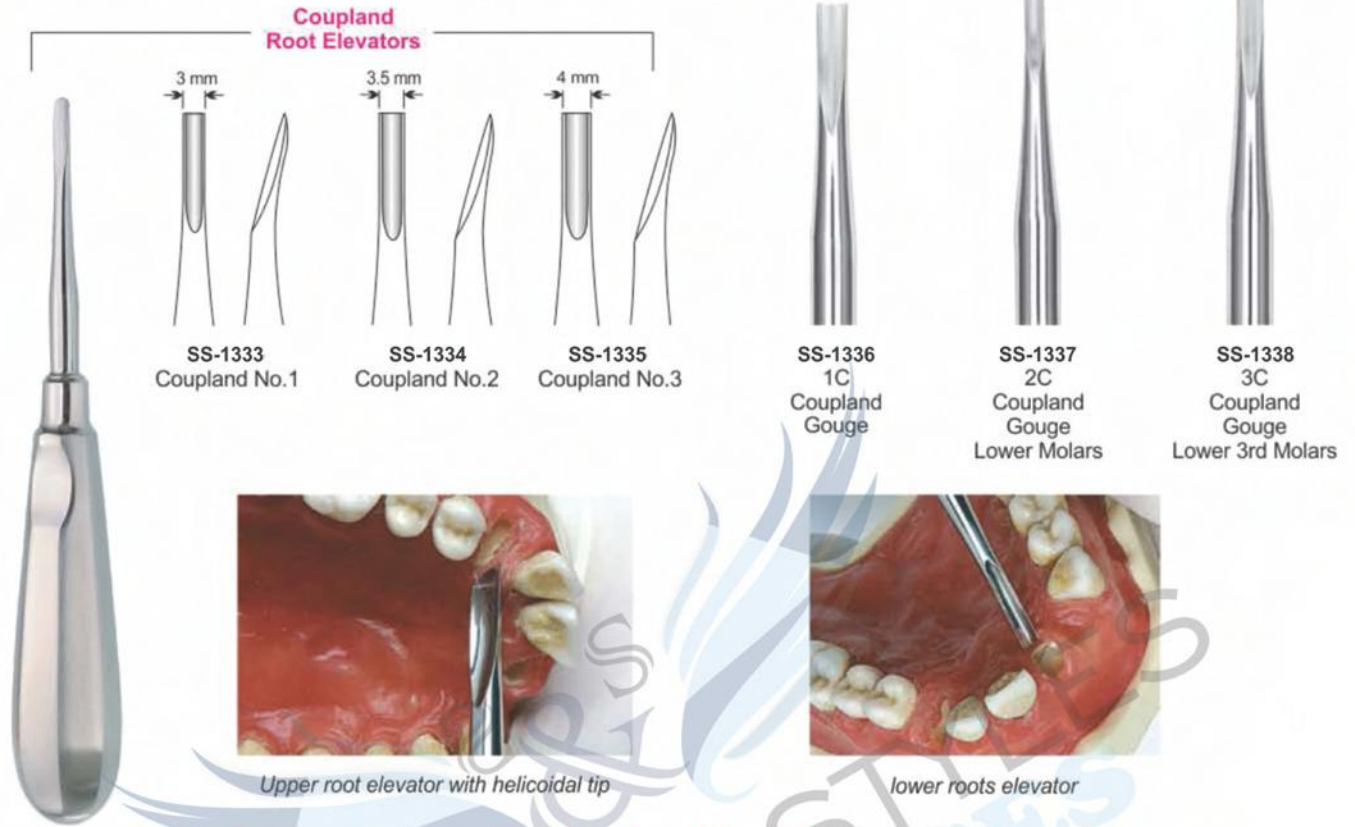

**FUNCTION:** To Loosen Tooth or Root From Bony Socket Prior to Placement of The Extraction Forceps.

## ENGLISH PATTERNS



# ROOT ELEVATOR

- Элеватор корневой экстракционный
- Elévateurs à racines
- Wurzelheber
- Слеватор корневий екстракційний
- Elevadores para raices
- المصاعد الجذر

## Lindo Levian Root Elevators

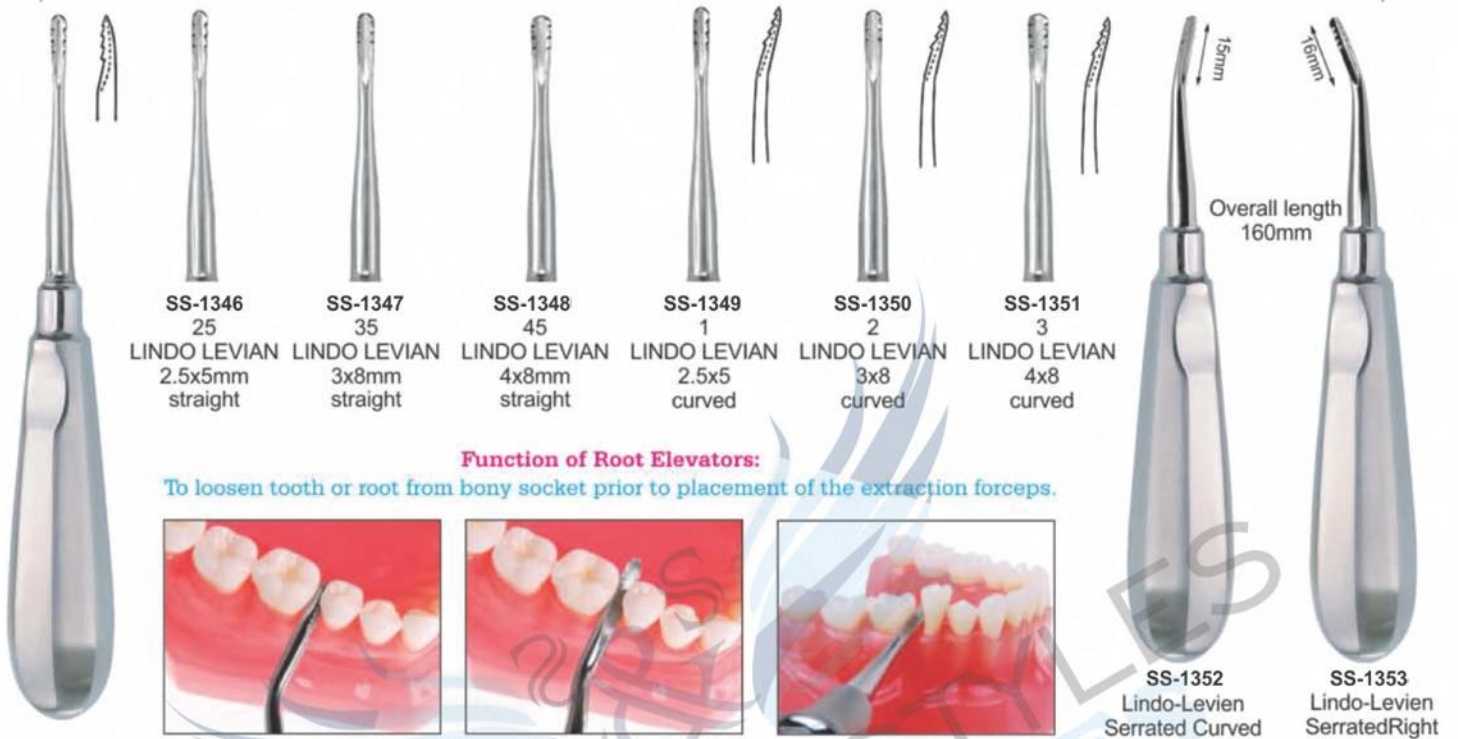

### Function of Root Elevators:

To loosen tooth or root from bony socket prior to placement of the extraction forceps.

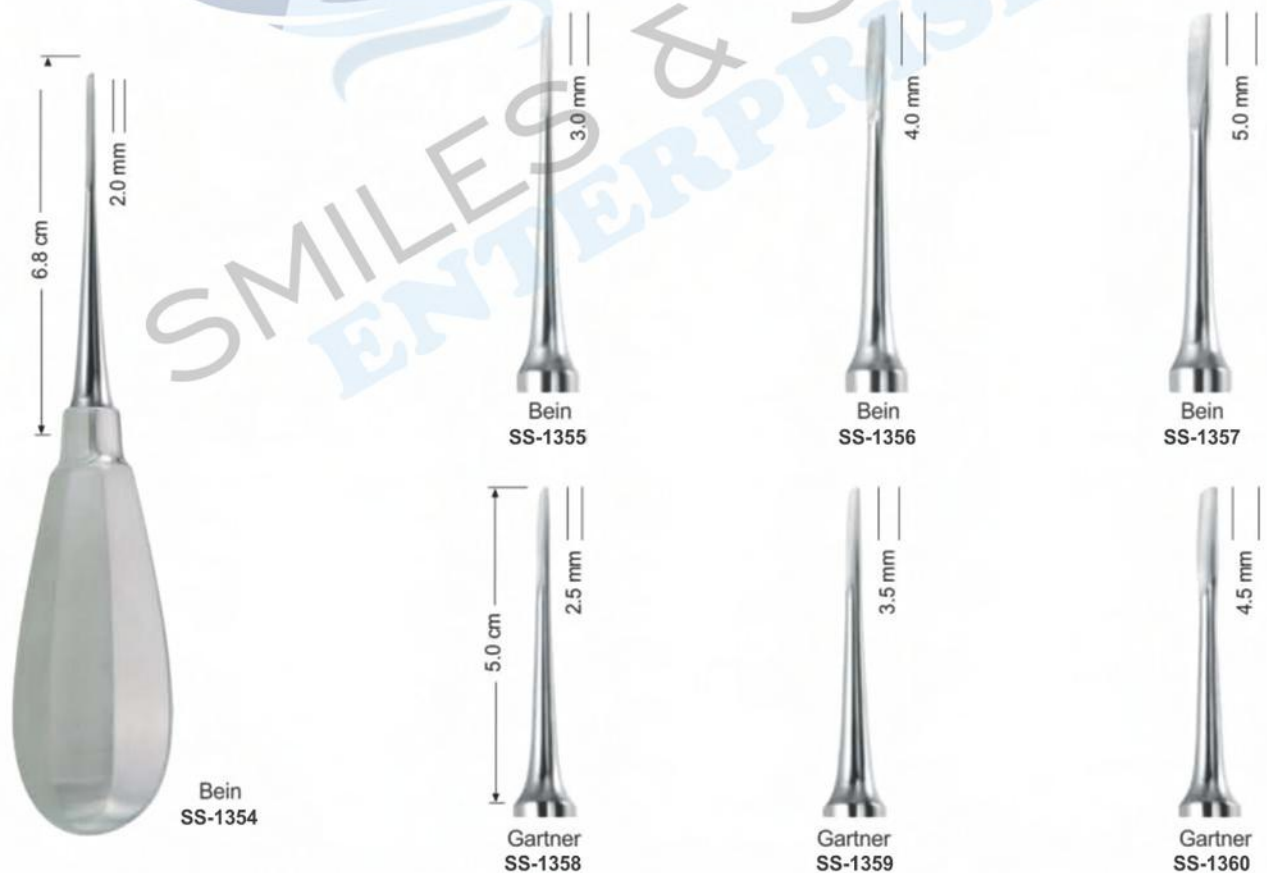



## ROOT ELEVATOR

- Элеватор корневой экстракционный
- Elévateurs à racines
- Wurzelheber
- Слеватор корневий экстракційний
- Elevadores para raices
- المصاعد الجذر

### Friedmann Roots Elevator



Hi1361  
Friedmann 4F  
Str.

SS-1362  
Friedmann 5F  
Left

Hi1363  
Friedmann 6F  
Right

### Luxating Elevator With Periotome Tip



SS-1364  
3mm Luxating  
Elevator / Periotome

SS-1365  
4mm Luxating  
Elevator / Periotome

SS-1366  
5mm Luxating  
Elevator / Periotome

### Wisdom Roots Elevator



SS-1367  
Wisdom  
for 18 and 38

SS-1368  
Wisdom  
for 28 and 48

**Function of Root Elevators:** To loosen tooth or root from bony socket prior to placement of the extraction forceps.

### Bayonet Roots Elevator Set



SS-1369  
Left

SS-1370  
Right

SS-1371  
bayonet

SS-1372  
Curved

SS-1373  
Straight

# ROOT ELEVATOR

- Элеватор корневой экстракционный
- Elévateurs à racines
- Wurzelheber
- Слеватор корневий екстракційний
- Elevadores para raices
- المصاعد الجذر

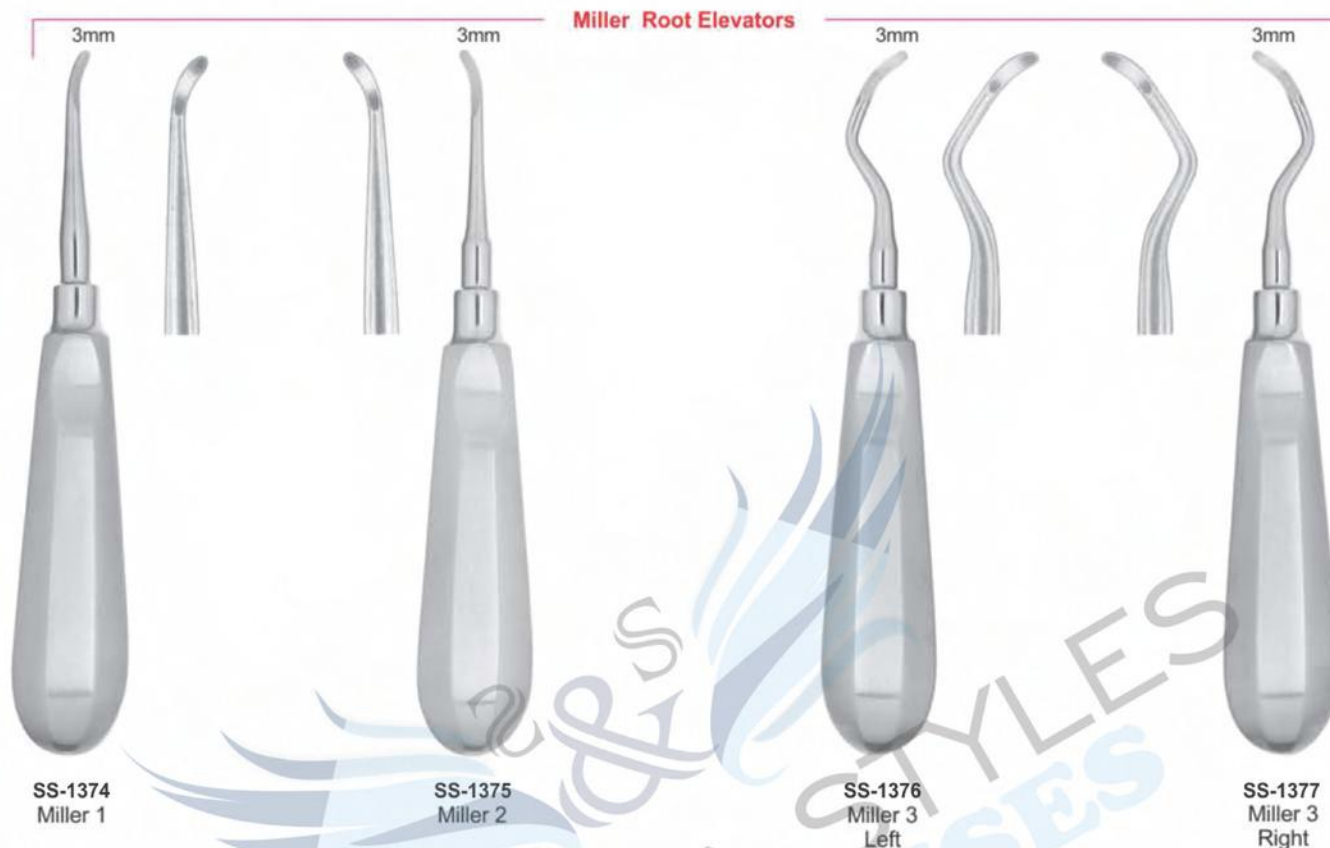

**Function of Root Elevators:** To loosen tooth or root from bony socket prior to placement of the extraction forceps.

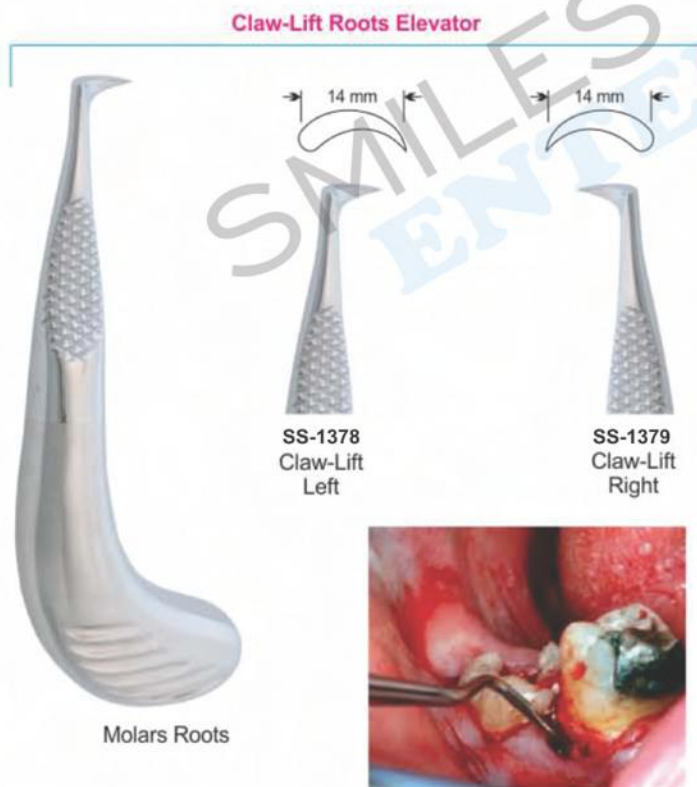



## ROOT ELEVATOR

- Элеватор корневой экстракционный
- Elévateurs à racines
- Wurzelheber
- Слеватор кореневий екстракційний
- Elevadores para raices
- المصاعد الجذر

**FUNCTION:** To Loosen Tooth or Root From Bony Socket Prior to Placement of The Extraction Forceps.

**Laxutor Root Elevators Set of 9 Pcs**



SS-1383  
2mm Str.



SS-1384  
3mm Str.



SS-1385  
5mm Str.



SS-1386  
3mm Cvd.



SS-1387  
5mm Cvd.



SS-1388  
3mm Angle



SS-1389  
3mm Angle



SS-1390  
3mm Str.



SS-1391  
5mm Str.

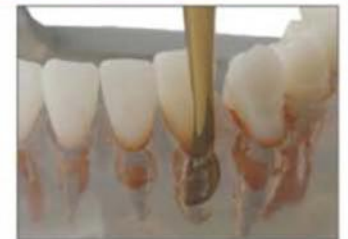

# ROOT ELEVATOR

- Элеватор корневой экстракционный
- Elévateurs à racines
- Wurzelheber
- Слеватор корневий екстракційний
- Elevadores para raices
- المصاعد الجذر

## Hyllin Roots Elevator



**Function of Root Elevators:** To loosen tooth or root from bony socket prior to placement of the extraction forceps.

## Kopp Roots Elevator

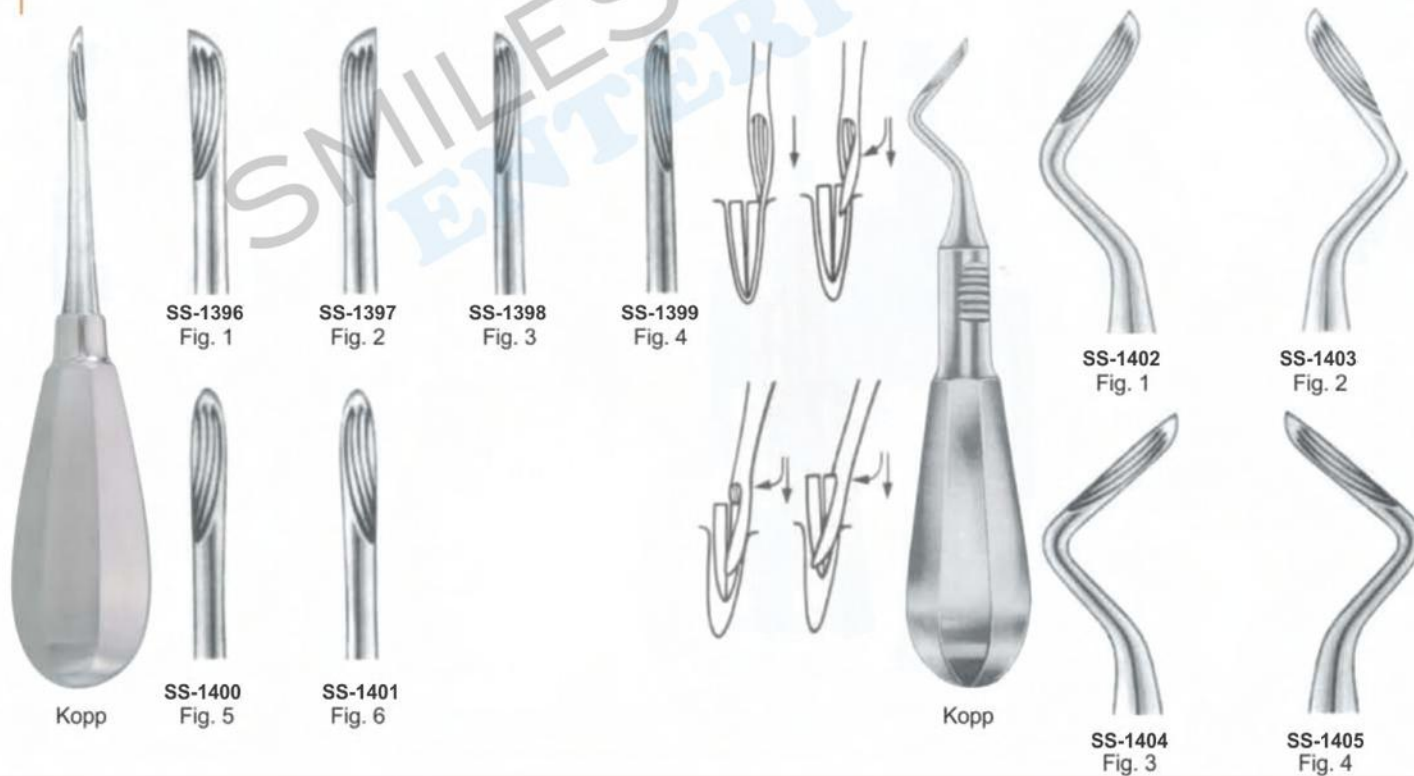



# ROOT ELEVATOR

- Элеватор корневой экстракционный
- Elévateurs à racines
- Wurzelheber
- Слеватор корневий экстракційний
- Elevadores para raices
- المصاعد الجذر

## Luxier Roots Elevator



SS-1406  
Luxier  
Cvd.

SS-1407  
Luxier  
Str.

## Heber Roots Elevator



SS-1408  
Heber  
Bayonet

SS-1409  
Heber  
Bayonet

## Bein Roots Elevator



SS-1410  
Bein,  
3mm

SS-1411  
Bein,  
4mm

**Function of Root Elevators:** To loosen tooth or root from bony socket prior to placement of the extraction forceps.

## Bein Roots Elevator



SS-1412  
Bein  
2mm  
serrated



Hi1413  
2mm  
straight  
serrated



SS-1414  
3mm  
straight



SS-1415  
4mm  
Curved



SS-1416  
Bein  
2mm, curved  
serrated



SS-1417  
2mm  
straight  
serrated



SS-1418  
3mm  
straight



SS-1419  
4mm  
Curved



SS-1420  
Bein  
2mm, curved  
serrated



SS-1421  
2mm  
straight  
serrated



SS-1422  
3mm  
straight



SS-1423  
4mm  
Curved

# ROOT ELEVATOR

- Элеватор корневой экстракционный
- Elévateurs à racines
- Wurzelheber
- Слеватор корневий екстракційний
- Elevadores para raices
- المصاعد الجذر

## W. Barry Roots Elevator



W. Barry  
Fig. 1  
(125mm)



SS-1424  
W. Barry  
Fig. 1



SS-1425  
W. Barry  
Fig. 2



SS-1426  
W. Barry  
Fig. 3



SS-1427  
W. Barry  
Fig. 4



**Function of Root Elevators:** To loosen tooth or root from bony socket prior to placement of the extraction forceps.



Winter  
Fig. 1L  
125mm



SS-1428  
Winter  
Fig. 1L



SS-1429  
Winter  
Fig. 1R



SS-1430  
775/3  
Winter  
11 L



SS-1431  
775/4  
Winter  
11 R



SS-1432  
775/5  
Winter  
12 L



SS-1433  
775/6  
Winter  
12 R



SS-1434  
775/7  
Winter  
13 L



SS-1435  
775/8  
Winter  
13 R



SS-1436  
Winter  
Fig. 1L



SS-1437  
Winter  
Fig. 1R



SS-1438  
Lecluse  
bayonet



SS-1439  
Potts "T-Handle"  
Elevator-Left



SS-1440  
Potts "T-Handle"  
Elevator-Right



## ROOT ELEVATOR

- Элеватор корневой экстракционный
- Elévateurs à racines
- Wurzelheber
- Слеватор корневий экстракційний
- Elevadores para raices
- المصاعد الجذر



SS-1441  
Fig. 1  
Chompret



SS-1442  
Fig. 2  
Chompret



SS-1443  
Fig. 3  
Chompret



SS-1444  
Fig. 4  
Chompret



*Lecluse elevator for lower third molar dislocation*



*Chompret syndesmotome, sickle pattern*

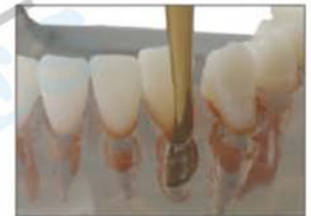
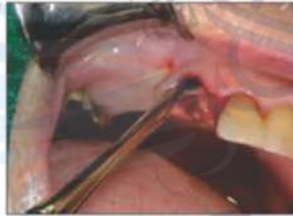

SS-1445



SS-1446



SS-1447



SS-1448



SS-1449



SS-1450



SS-1451

### Root Pick Elevator With Gold Flexible Points

# ROOT ELEVATOR

- Элеватор корневой экстракционный
- Elévateurs à racines
- Wurzelheber
- Слеватор корневий екстракційний
- Elevadores para raices
- المصاعد الجذر

## Heidbrink Roots Elevator



SS-1452  
Heidbrink  
Straight

SS-1453  
Heidbrink  
Left

SS-1454  
Heidbrink  
Right

SS-1455  
Heidbrink  
Straight

SS-1456  
Heidbrink  
Left

SS-1457  
Heidbrink  
Right

## Syndesmotomes Roots Elevator



SS-1458  
Straight

SS-1459  
Left

SS-1460  
Right

## Periotome Roots Elevator



SS-1461  
Periotome  
2.1mm  
Straight

SS-1462  
Periotome  
2.6mm  
Straight

SS-1463  
Periotome  
2.1mm  
Angular

SS-1464  
Periotome  
2mm  
Curved

SS-1465  
Periotome  
2.0mm

SS-1466  
Periotome  
2.5mm

SS-1467  
Periotome  
3.0mm

SS-1468  
Periotome  
4.0mm

Syndesmotomes



## ROOT ELEVATOR

- Элеватор корневой экстракционный
- Elévateurs à racines
- Wurzelheber
- Слеватор корневий экстракційний
- Elevadores para raices
- المصاعد الجذر

**FUNCTION:** To loosen small root fragments from bony socket

### Heidbrink Roots Elevator

### Warwick-James

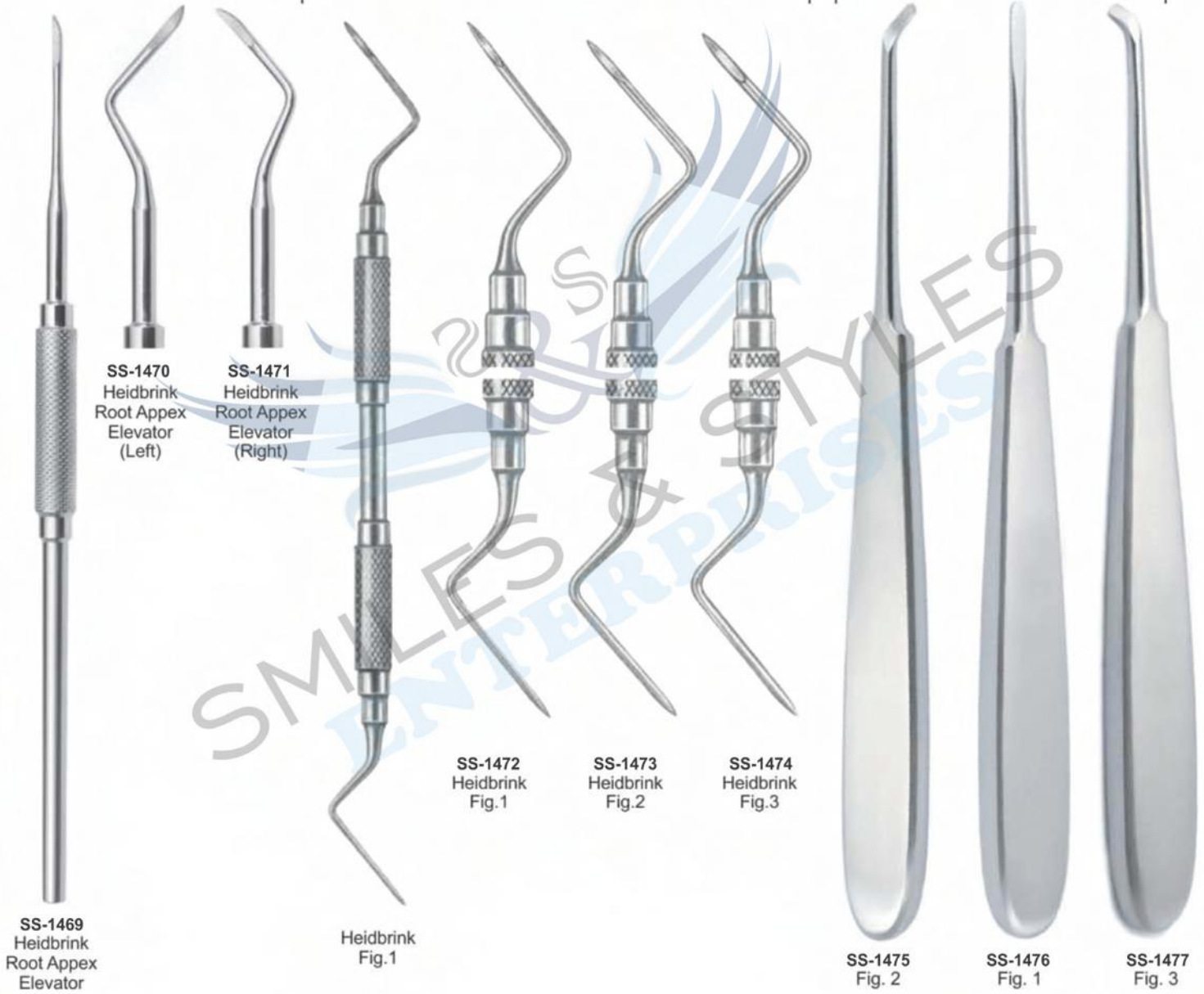

# ROOT ELEVATOR

- Элеватор корневой экстракционный
- Elévateurs à racines
- Wurzelheber
- Слеватор корневий екстракційний
- Elevadores para raices
- المصاعد الجذر



SS-1478  
1S  
(Straight 1mm)



SS-1479  
2S  
(Straight 2mm)



SS-1480  
3S  
(Straight 3mm)



SS-1481  
5S  
(Straight 5mm)



SS-1482  
3C  
(Curved 3mm)



SS-1483  
5C  
(Curved 5mm)



SS-1484  
3CA  
(Curved Angle 3mm)



SS-1485  
3IC  
(Inverted Curved 3mm)



SS-1486  
DE 3  
(Dual Edge 3mm / 1.5mm)



SS-1487  
DE 5  
(Dual Edge 5mm / 3mm)



## ROOT ELEVATOR

- Элеватор корневой экстракционный
- Elévateurs à racines
- Wurzelheber
- Слеватор корневий екстракційний
- Elevadores para raices
- المصاعد الجذر



SS-1488  
Luxators Set of 7 Pcs



SS-1489  
Luxators Set of 7 Pcs



SS-1490  
Luxators Set of 8 Pcs



SS-1491  
Root Elevators Set of 10 Pcs



SS-1492  
Elevators Set of 8 Pcs



SS-1493  
Elevators Set of 8 Pcs

# ROOT ELEVATOR

- Элеватор корневой экстракционный
  - Elévateurs à racines
  - Wurzelheber
- Єлеватор корневий екстракційний
  - Elevadores para raices
  - المصاعد الجذر

## PDL ELEVATORS

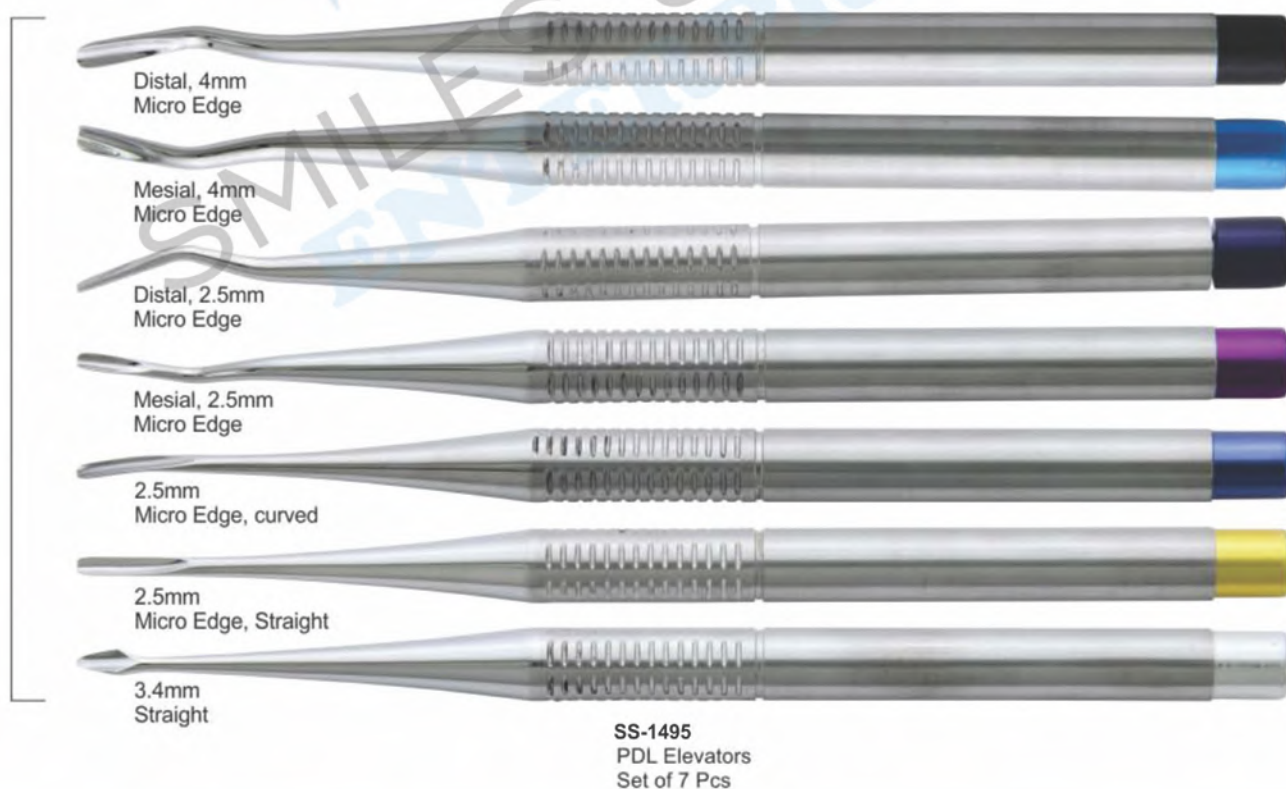



## ROOT ELEVATOR

- Элеватор корневой экстракционный
- Elévateurs à racines
- Wurzelheber
- Слеватор корневий экстракційний
- Elevadores para raices
- المصاعد الجذر

## PDL ELEVATORS

Delicate Arrow tip



4,0mm straight  
4,0mm curved

Luxivators straight  
atraumatic luxation of the tooth



2,5mm straight  
3,5mm straight  
4,5mm straight

Luxivators curved  
atraumatic luxation of the tooth



2,5mm curved  
3,5mm curved  
4,5mm curved



SS-1496  
PDL Elevators  
Set of 8 Pcs

## Our Scalers

Compare our scalers and curettes with the best in the industry and you will immediately recognize we are equal in every way but one... price. Note the deep precision knurling for better tactile feel. The same high-grade stainless steel tips, the same light weight (under 18 grams) for less hand fatigue, the same professional craftsmanship, and surpassing the highest industry standards. of course, any manufacturer can make these claims, but we guarantee and certify ours.

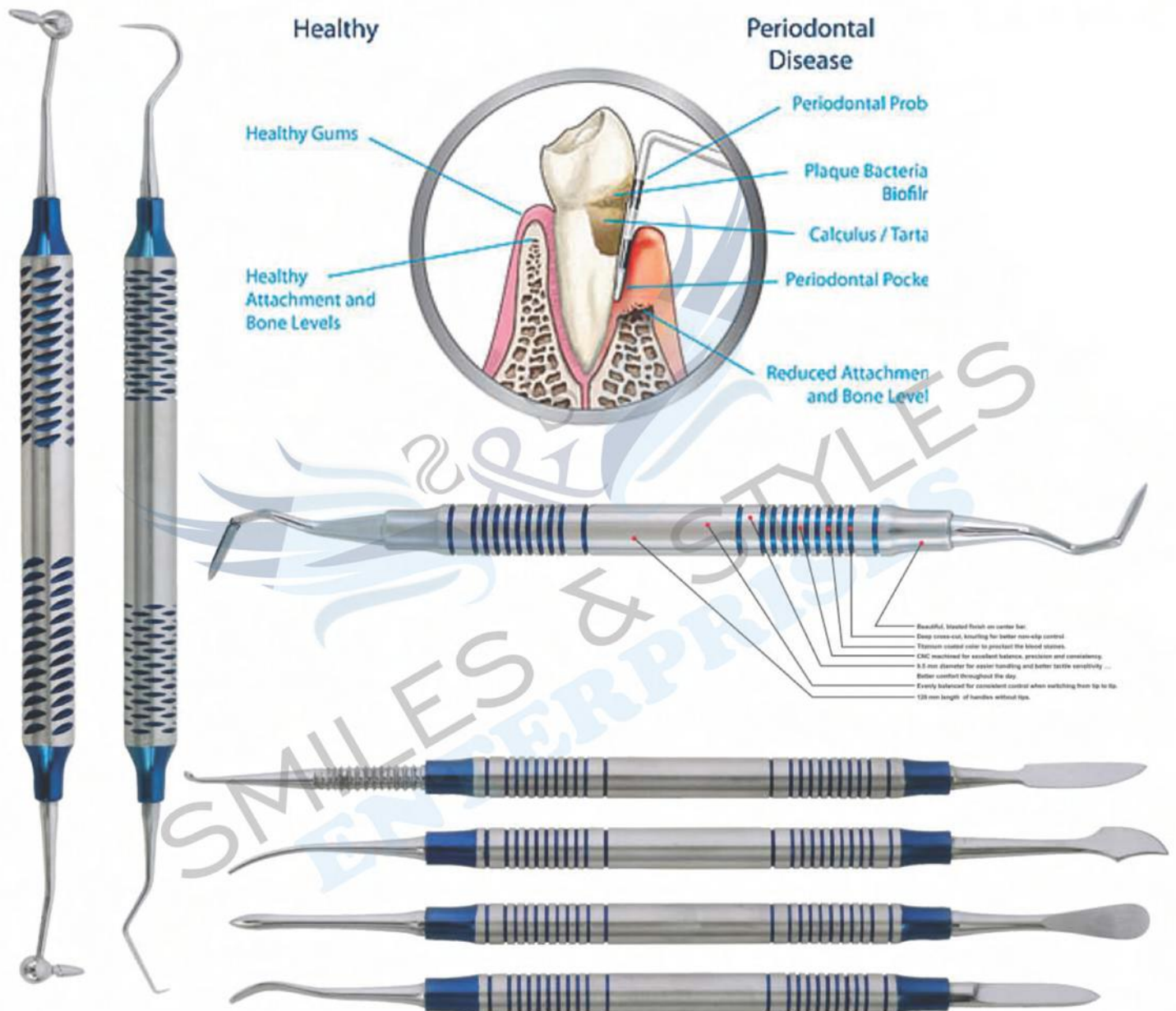

- High-polish mirror finish tips.
- Manufactured within the guidelines of the FDA quality assurance system for good manufacturing practices.
- Highest grade German stainless steel, razor sharp, durable tips. Rockwell hardened to 60 RHc.
- 27 of the most popular designs from graces to McCalls to columbias, and many european patterns.
- All instruments are guaranteed against defects in material and workmanship.

- All instruments bear the ce mark, emblematic of the european community's highest standards.
- Customer satisfaction guarantee, too!
- Less than 20 grams ... Lightweight for less hand fatigue.
- Manufactured to the most exacting standards so the 50th instrument you buy is exactly like your first.
- You decide ... Why pay more for the same high-quality instruments?



## DIAGNOSTIC, PERIODONTAL & RESTORATIVE INSTRUMENTS

### VALUED BUYERS

Compare our scalers and curettes with the best in the industry and you will immediately recognize we are equal in every way but one... price. Note the deep precision knurling for better tactile feel. The same high-grade stainless steel tips, the same light weight (under 20 grams) for less hand fatigue, the same professional craftsmanship, and surpassing the highest industry standards. Of course, any manufacturer can make these claims, but we guarantee and certify ours. We regularly manufacturing below articles in showing handles & pattern A to L for better grip & perfection. We are also fully equipped & capable to develop these instruments as per your own specific requirements & demands in materials, sizes, shapes and patterns.



A-Hollow Handle Ø 10 mm



B-Hollow Handle Ø 10 mm



C-Hollow Handle Ø 10 mm



D-Hollow Handle Ø 10 mm



E-Hollow Handle Ø 10 mm



F-Hollow Handle Ø 10 mm



G-Hollow Handle Ø 10 mm



H-Hollow Handle Ø 6.4 mm



I-Hollow Handle Ø 8 mm



J-Hollow Handle Ø 10 mm



K-Soild Handle Ø 6 mm



L-Soild Handle Ø 6 mm

# MOUTH MIRRORS

- зеркала
- Espejos de la boca
- Mundspiegel
- дзеркала
- Miroirs à la bouche
- مرايا الفم

## Plain



SS-1497 Fig. 3 Ø20mm  
 SS-1498 Fig. 4 Ø22mm  
 SS-1499 Fig. 5 Ø24mm  
 SS-1500 Fig. 6 Ø26mm

## Cone-Socket Plain



SS-1511 Fig. 3 Ø20mm  
 SS-1512 Fig. 4 Ø22mm  
 SS-1513 Fig. 5 Ø24mm

## Magnifying



SS-1501 Fig. 3 Ø20 mm  
 SS-1502 Fig. 4 Ø22 mm  
 SS-1503 Fig. 5 Ø24 mm

## Cone-Socket Magnifying



SS-1514 Fig. 3 Ø20mm  
 SS-1515 Fig. 4 Ø22mm  
 SS-1516 Fig. 5 Ø24mm

## Rhodium



SS-1504 Fig. 3 Ø20mm  
 SS-1505 Fig. 4 Ø22mm  
 SS-1506 Fig. 5 Ø24 mm

## Cone-Socket Rhodium



SS-1517 Fig. 3 Ø20mm  
 SS-1518 Fig. 4 Ø22mm  
 SS-1519 Fig. 5 Ø24mm

## Front Surface



SS-1507 Fig. 3 Ø20mm  
 SS-1508 Fig. 4 Ø22mm  
 SS-1509 Fig. 5 Ø24mm  
 SS-1510 Fig. 6 Ø26mm

## Cone-Socket Front Surface



SS-1520 Fig. 3 Ø20mm  
 SS-1521 Fig. 4 Ø22mm  
 SS-1522 Fig. 5 Ø24mm



## HANDLES FOR MOUTH MIRRORS

- Ручки для зеркал
- Manches pour miroirs à bouche
- Mundspiegelgriffe
- Ручки для дзеркал
- Mangos para espejos de boca
- مقابض لمرآيا الفم



SS-1523  
Hollow Mirror  
Handle Round  
Ø 10 mm



SS-1524  
Hollow Mirror  
Hexagonal  
Handle  
Ø 8 mm



SS-1525  
Hollow  
Ø 8 mm



SS-1526  
Hollow Mirror  
Hexagonal  
Handle  
Ø 10 mm



SS-1527  
Hollow Mirror  
Handle  
Ø 8 mm



SS-1528  
Hollow Mirror  
Handle  
Ø 10 mm

### Cone-Socket Mirror Handle



SS-1529  
Mirror Handle  
Solid  
Ø 6 mm



SS-1530  
Mirror Handle  
Solid  
Ø 6 mm



SS-1531  
Mirror Handle  
Solid Octagonal  
Ø 6 mm



SS-1532  
Mirror Handle  
Stem  
with Rule  
35mm



SS-1533  
Mirror Handle  
Solid  
Stem with  
Rule 35mm



SS-1534  
Cone-Socket  
Solid Octagonal  
Ø 6 mm



SS-1535  
Cone-socket  
Solid  
Ø 6 mm



SS-1536  
Cone-socket  
Hexagonal  
Handle  
Ø 6 mm

# EXPLORERS

- Зонды
  - Sondes
  - Zahnsonden
- Зонди
  - Sondas
  - المستكشفين

Examination kit Set of 3 Pieces



SS-1537 Probe  
HIR-1538 Mirror  
SS-1539 College Forcep 15cm



Examination Set of 4 Pieces



SS-1540 Exp,23/17-A  
SS-1541 Exavators  
SS-1542 Tweezers  
SS-1543 Mouth Mirror

SS-1544

First Aid Examination Set of 3 Pieces



SS-1545

First Aid Examination Set of 3 Pieces



SS-1546

First Aid Examination Set of 3 Pieces



SS-1547

First Aid Examination Set of 3 Pieces





## TWEEZERS

- Пинцеты
- Précelles - Brucelles
- Zahnpinzetten
- Пинцети
- Pinzas para algodón
- ملاقط



SS-1548  
Surgical  
11.5cm



SS-1549  
London College  
15cm



SS-1550  
Semken Taylor  
Str.



SS-1550  
Semken Taylor  
Cvd.



SS-1551  
Meriam  
16cm



SS-1552  
Dressing  
14cm



SS-1553  
Semken Taylor  
1x2 Straight



SS-1554  
Semken Taylor  
1x2 Curved



SS-1555  
Gilles  
15cm 1x2



SS-1556  
14cm 1x2



SS-1557  
Perry  
13cm



SS-1558  
Atraumatic  
15cm Cvd



SS-1559  
Atraumatic  
15cm Str.



SS-1560  
College with Lock  
15cm Cvd.



SS-1561  
Gerald  
17.5cm



SS-1562  
with lock  
15cm



SS-1563  
Atraumatic  
17.5cm

# TWEEZERS

- Пинцеты
- Précelles - Brucelles
- Zahnpinzetten

- Пинцети
- Pinzas para algodón
- ملاقط



SS-1566  
Adson-TC  
12cm



SS-1567  
Adson-TC  
12cm 1x2



SS-1568  
Adson-TC  
15cm 1x2



SS-1569  
Adson  
12cm



SS-1570  
Adson  
12cm 1x2



SS-1571  
Adson  
15cm 1x2



SS-1572  
Adson Brown  
12cm



SS-1573  
Crane Kaplan  
15cm



SS-1574  
Crane Kaplan  
15cm



SS-1575  
Crane Kaplan  
15cm



SS-1576  
Hemingway  
15cm



SS-1577  
Miller  
15cm Str.



SS-1578  
Miller  
15cm Cvd.



SS-1579  
Dressing  
Tweezer  
14.5cm



SS-1580  
College  
Curved  
Tip 15cm



SS-1581  
Maryam  
Tweezers  
15cm



SS-1582  
College  
Tweezer  
15cm



SS-1583  
Perry  
Tweezer  
12.5cm



SS-1584  
Self-locking  
Tweezer  
15cm



# EXPLORERS

- Зонды
- Sondes
- Zahnsonden
- Зонди
- Sondas
- المستكشفين

Single Ended Probe Solid Handle 4.5mm Length 150mm



Explorers-Single-End

Double-Ended Explorers

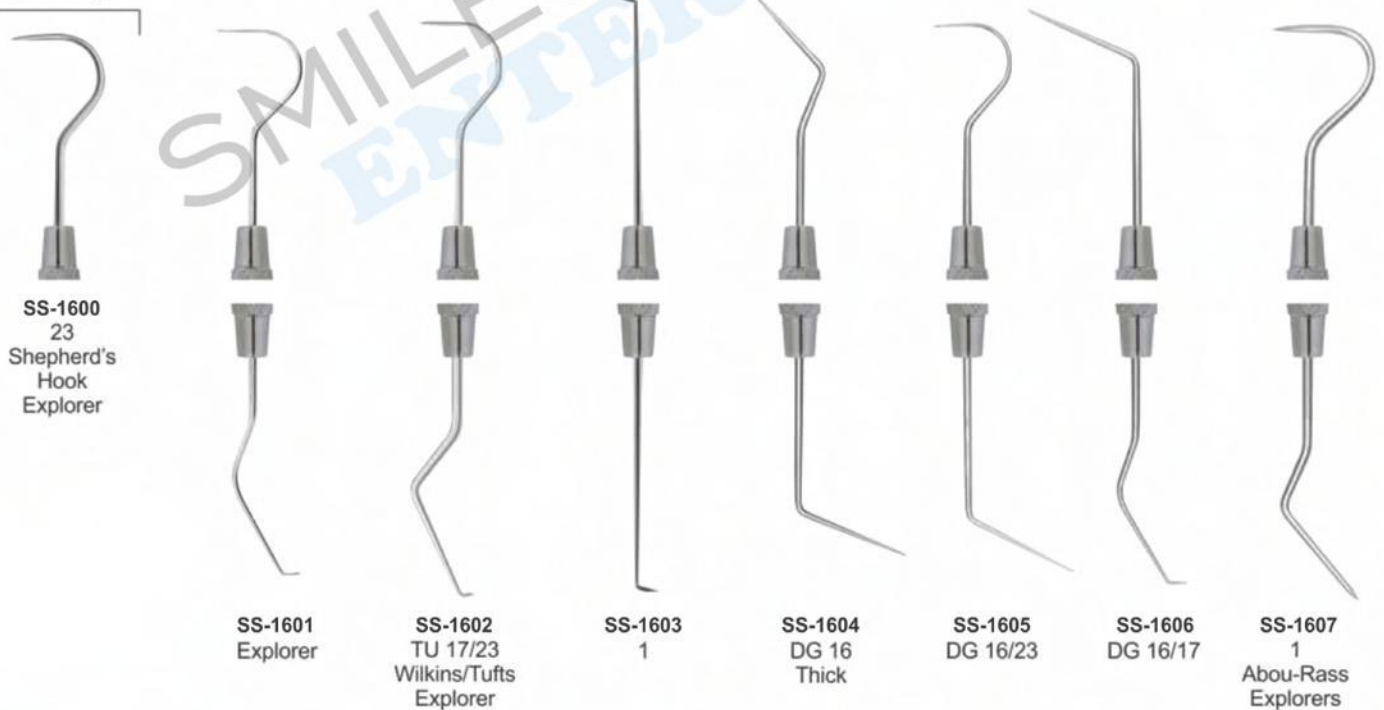

# EXPLORERS

- Зонды
  - Sondes
  - Zahnsonden
- Зонди
  - Sondas
  - المستكشفين

Probes Double Ended 6mm, length 170mm



**SS-1608-A**  
23/UNC1  
university of north  
carolina Explorer

**SS-1608-B**  
Goldman Fox  
Fig.17

**SS-1608-C**  
University  
of Michigan  
Fig.17

**HI1608-D**  
Williams  
Fig.17

**SS-1608-E**  
Goldman Fox  
Fig.16

**SS-1608-F**  
University  
of Michigan  
Fig.16

**SS-1608-G**  
Williams  
Fig.16

Pointed Probes Double Ended Handle 6mm, length 170mm



**SS-1608**  
Williams



**SS-1609**  
Goldman Fox  
Williams



**SS-1610**  
Goldman Fox  
Merrit B



**SS-1611**  
Goldman Fox  
University of  
Michigan



**SS-1612**  
University  
of Michigan  
Fig.23



**SS-1613**  
Williams  
Fig.23



# EXPLORERS

- Зонды
  - Sondes
  - Zahnsonden
- Зонди
  - Sondas
  - المستكشفين

EXPLORERS INSTRUMENTS SOLID HANDLE 6MM, LENGTH 170MM

## PLUGGERS

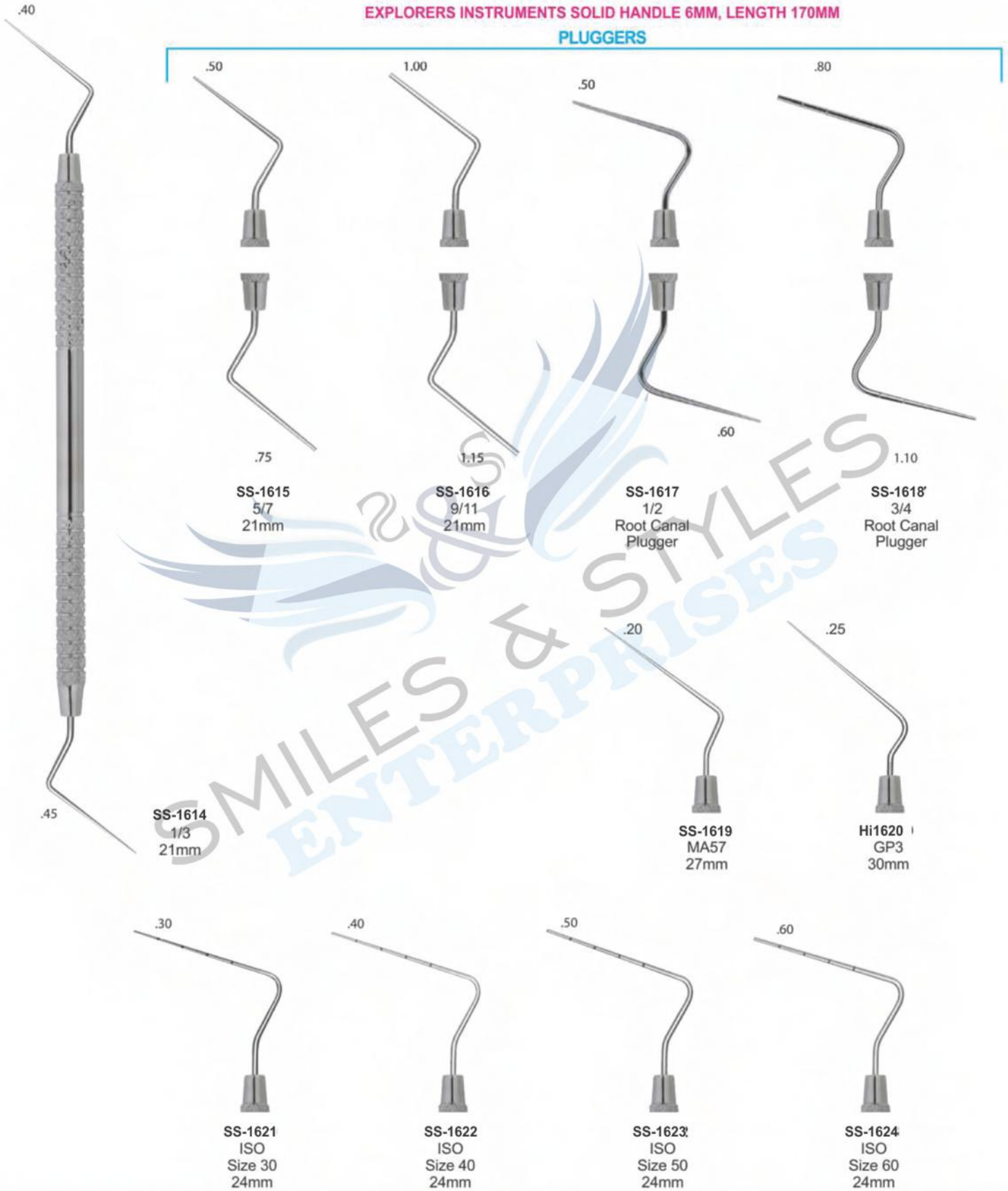

# PERIODONTAL PROBES

- Зонды пародонтологические
  - Sondes parodontales
  - sonde parodontall
- зонди пародонтологічні
  - Sondas parodontales
  - المسابر اللثة

## SPREADERS

## HEAT CARRIERS

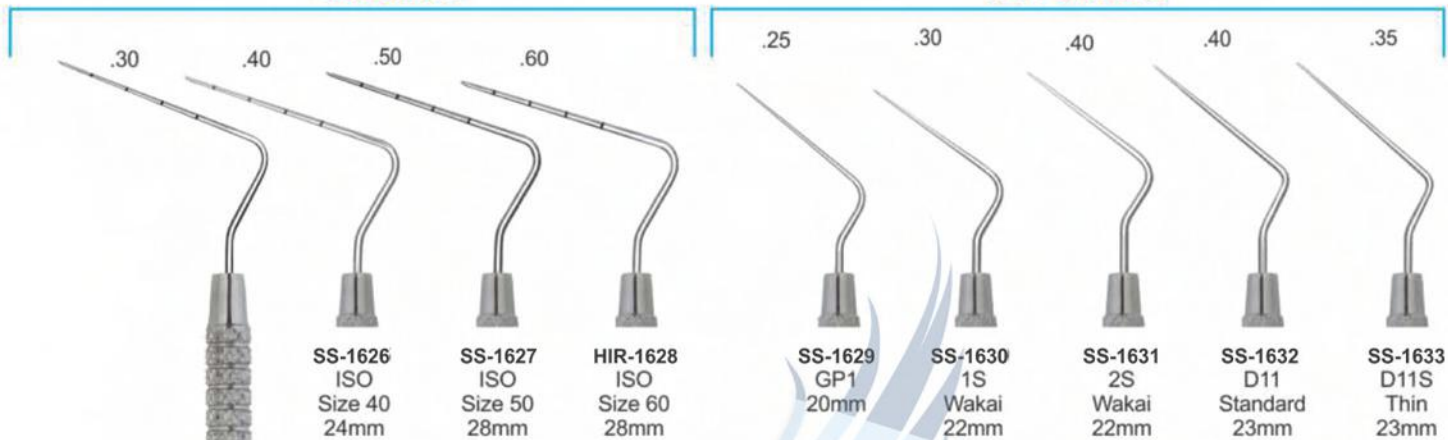

## HEAT CARRIERS

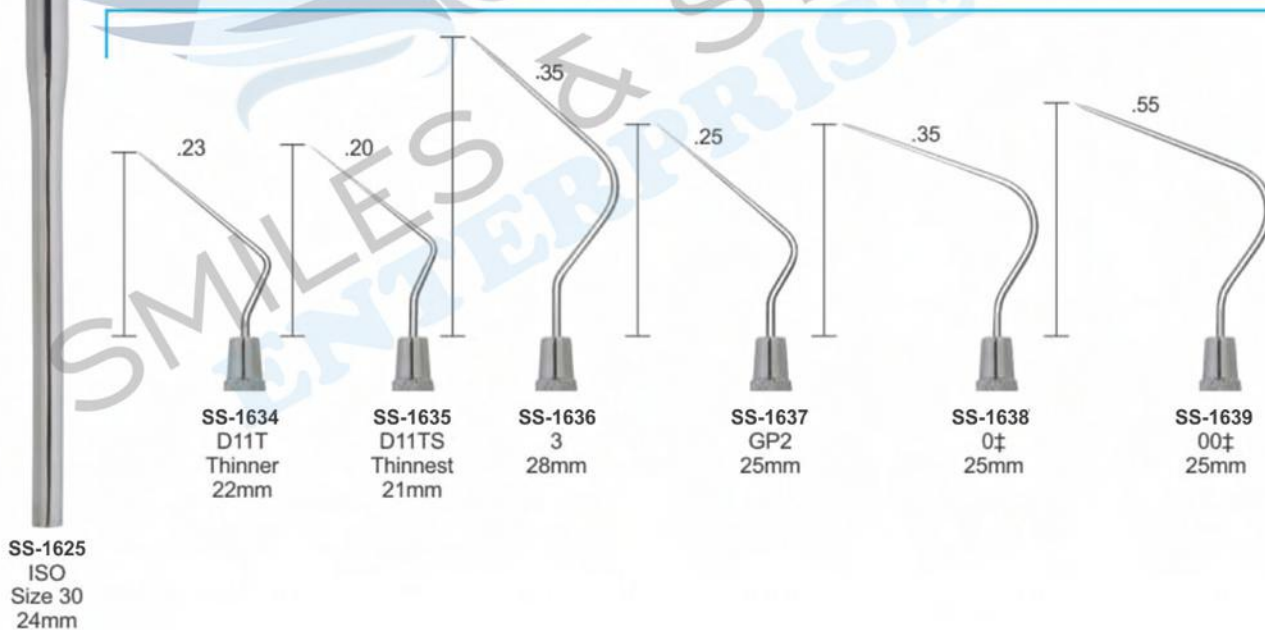



# PERIODONTAL PROBES

- Зонды пародонтологические
- Sondes parodontales
- sonda parodontali
- зонди пародонтологічні
- Sondas parodontales
- المسابر اللثة

## ENDODONTICS INSTRUMENTS

### ANTERIOR

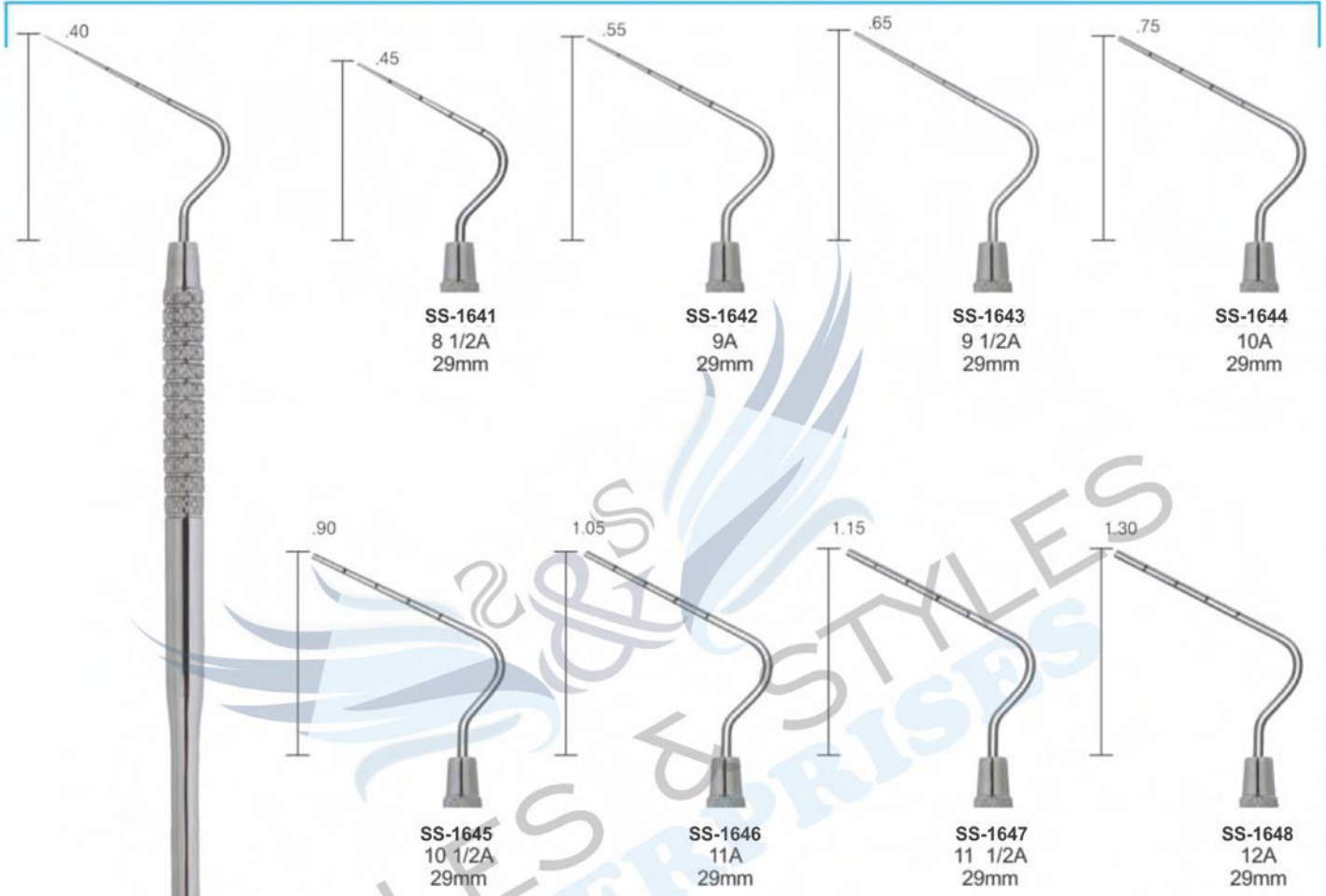

### LUKS

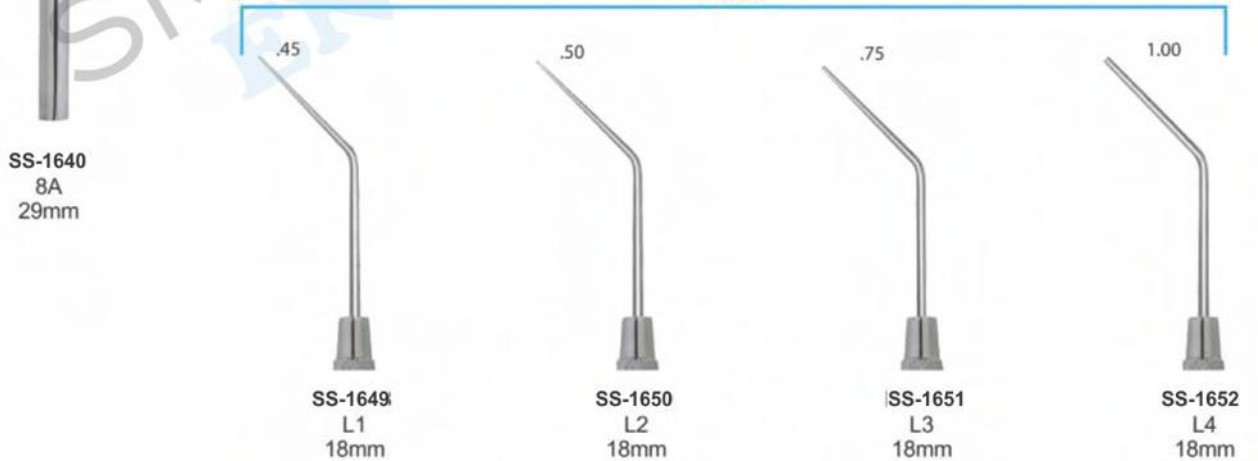

# SCALER



SS-1653  
Gracey Curettes 1/2



SS-1654  
Gracey Curettes 3/4



SS-1655  
Gracey Curettes 5/6



SS-1656  
Gracey Curettes 7/8



SS-1657  
Gracey Curettes 9/10



SS-1658  
Gracey Curettes 11/12



SS-1659  
Gracey Curettes 13/14



SS-1660  
Gracey Curettes 1/2



SS-1661  
Gracey Curettes 3/4



SS-1662  
Gracey Curettes 5/6



SS-1663  
Gracey Curettes 7/8



SS-1664  
Gracey Curettes 9/10



SS-1665  
Gracey Curettes 11/12



SS-1666  
Gracey Curettes 13/14





# SCALER

## GRACEY MINI FIVE

Hollow Handle 9.5mm, Length 170mm Ceramic Coated Handle



SS-1668  
Fig. 3/4 Gracey 3M



SS-1669  
Fig. 5/6 Gracey 3M



SS-1670  
Fig. 7/8 Gracey 3M  
Buccal and lingual/  
Palatal surfaces



SS-1671  
Fig. 11/12 Gracey 3M  
Mesial



SS-1672  
Fig. 13/14 Gracey 3M  
Distal

SS-1667  
Fig. 1/2  
Gracey 3m



## GRACEY AFTER FIVE

Hollow Handle 9.5mm, Length 170mm Ceramic Coated Handle



SS-1674  
Gracey 3/4 AF



SS-1675  
Gracey 5/6 AF



SS-1676  
Gracey 7/8 AF



SS-1677  
Gracey 11/12 AF



SS-1678  
Gracey 13/14 AF

SS-1673  
Gracey  
1/2 AF



## Gracey Curettes



$\frac{3...1}{3...1} | \frac{1...3}{1...3}$  SS-1679 Fig. 1/2 GR - Gracey  
Buccal surfaces



$\frac{5...1}{5...1} | \frac{1...5}{1...5}$  SS-1680 Fig. 3/4 GR - Gracey  
Lingual/Palatal surfaces



$\frac{5...1}{5...1} | \frac{1...5}{1...5}$  SS-1681 Fig. 5/6 GR - Gracey



$\frac{8...4}{8...4} | \frac{4...8}{4...8}$  SS-1682 Fig. 7/8 GR - Gracey  
Buccal and lingual/  
palatal surfaces



$\frac{8...4}{8...4} | \frac{4...8}{4...8}$  SS-1683 Fig. 9/10 GR - Gracey  
Buccal and lingual/  
palatal surfaces more angled

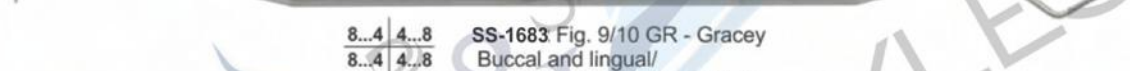

$\frac{8...4}{8...4} | \frac{4...8}{4...8}$  SS-1684 Fig. 11/12 GR - Gracey  
Mesial



$\frac{8...4}{8...4} | \frac{4...8}{4...8}$  SS-1685 Fig. 13/14 GR - Gracey  
Distal



$\frac{8...4}{8...4} | \frac{4...8}{4...8}$  SS-1686 Fig. 15/16 GR - Gracey  
Mesial



$\frac{8...4}{8...4} | \frac{4...8}{4...8}$  SS-1687 Fig. 17/18 GR - Gracey  
Distal



- # 1/2 - # 3/4 - # 5/6
- # 7/8 - # 9/10
- # 11/12 - # 13/14
- # 15/16 - # 17/18

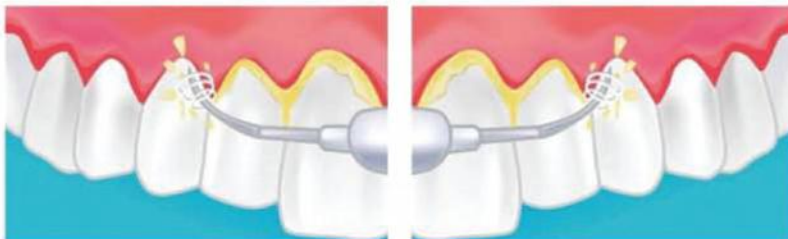

- # 1/2 - # 3/4 - # 5/6
- # 7/8 - # 9/10
- # 11/12 - # 13/14
- # 15/16 - # 17/18



# SCALER

## Sickle Scalars



SS-1688 Fig. U15/33 - Towner-Jaquette



SS-1689 Fig. U15/30 - Towner-Jaquette



SS-1690 Fig. H5/33



SS-1691 Fig. H6/H7



SS-1692 Fig. 30/33 - Jaquette



SS-1693 Fig. T2/T3 - Taylor



SS-1694 Fig. 204



SS-1695 Fig. 204S



SS-1696 Fig. 11/12 - MC - McCall  
Mesial



SS-1697 Fig. 13/14 - MC - McCall  
Distal

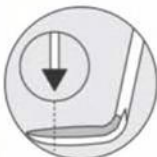

**Straight and curved sickle scalars**  
Feature: 2 cutting edges curved facial component tipped ends

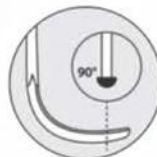

**Universal curettes**  
are characterized by an angle of 90° between the terminal stem and the cutting component.

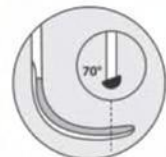

**Gracey curettes**  
are characterized by an angle of 70° between the terminal stem and the cutting component.

Universal Curettes



SS-1698 Fig. 13S/14S - MC - McCall



SS-1699 Fig. 17S/18S - MC - McCall  
Distal



SS-1700 Fig. M23



SS-1701 Fig. 204SD



SS-1702 Fig. YG7/8-Younger Good



SS-1703 Fig. L 1/2 - Langer



SS-1704 Fig. L 3/4 - Langer



SS-1705 Fig. L 5/6 - Langer



SS-1706 Fig. M 23A



SS-1707 Fig. M 23B

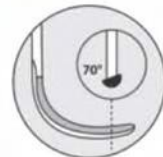
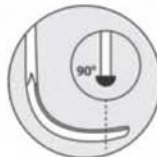

**Straight and curved sickle scalers**  
Feature: 2 cutting edges curved facial component tipped ends

**Universal curettes**  
are characterized by an angle of 90° between the terminal stem and the cutting component.

**Gracey curettes**  
are characterized by an angle of 70° between the terminal stem and the cutting component.



Periodontal knives



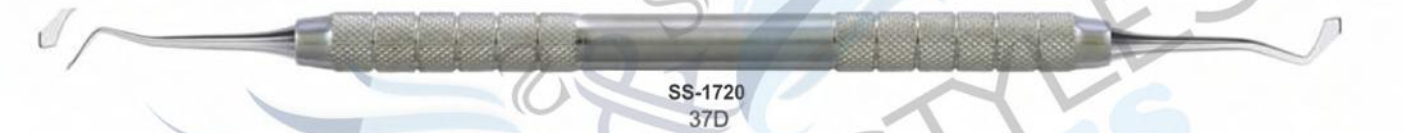

Chisels  
Diamond coated margin trimmers



Thanks to the diamond-coated hand instruments the margins are evenly levelled.



## SCALER

### Margin trimmers



CHISELS



SS-1739  
1/2 Werdelstaedt



SS-1740  
3/4 Werdelstaedt



SS-1741  
7 Straight



SS-1742  
5/6 Straight



SS-1743  
7/10 Straight



SS-1744  
8/9 Binangle



SS-1745  
11/12 Binangle



SS-1746  
40/41 Binangle

Tartar Remover Instruments Solid Handle Ø 6 mm



SS-1748  
Fig. 1L  
Left

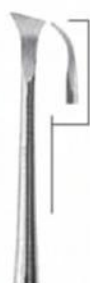

SS-1749  
Fig. 1R  
Right



SS-1750  
Fig. 2L  
left



SS-1751  
Fig. 2R  
Right



SS-1752



SS-1753



SS-1754



## BURNISHERS CONSERVATIVE TREATMENT

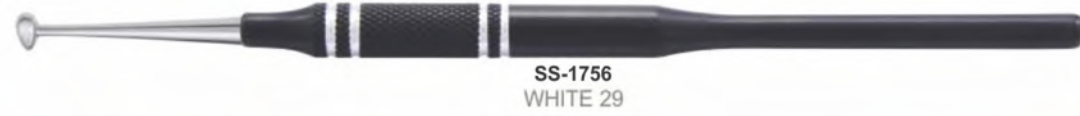

# FILLING INSTRUMENTS CONSERVATIVE TREATMENT



SS-1767



SS-1768



SS-1769



SS-1770



SS-1771



SS-1772



SS-1773



SS-1774



SS-1775



SS-1776  
PLANATOR



SS-1777  
PLANATOR





## Ball Burnishers



SS-1786



SS-1787



SS-1788



SS-1789



## Hatches

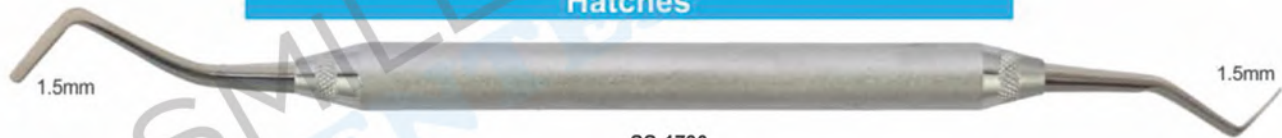

SS-1790



SS-1791



SS-1792  
Mini-Spatel



SS-1793  
Mini-Spatel



# COMPOSITE INSTRUMENTS

## Spatulas rounded and sharp

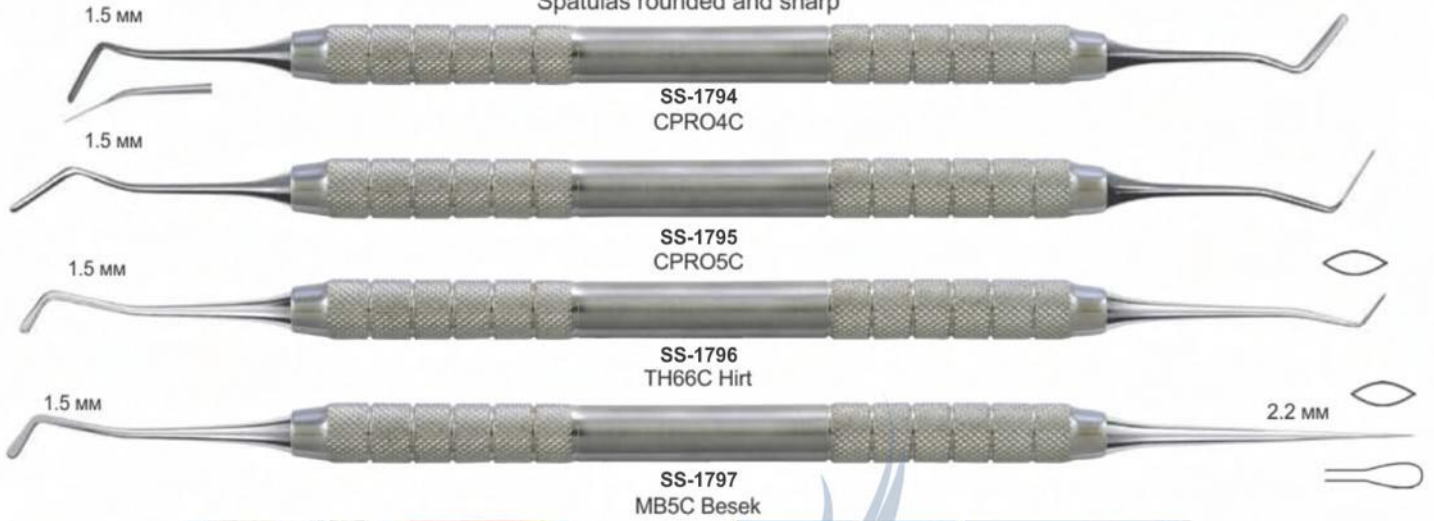

## Spatulas Blade Thickness 0.22 MM

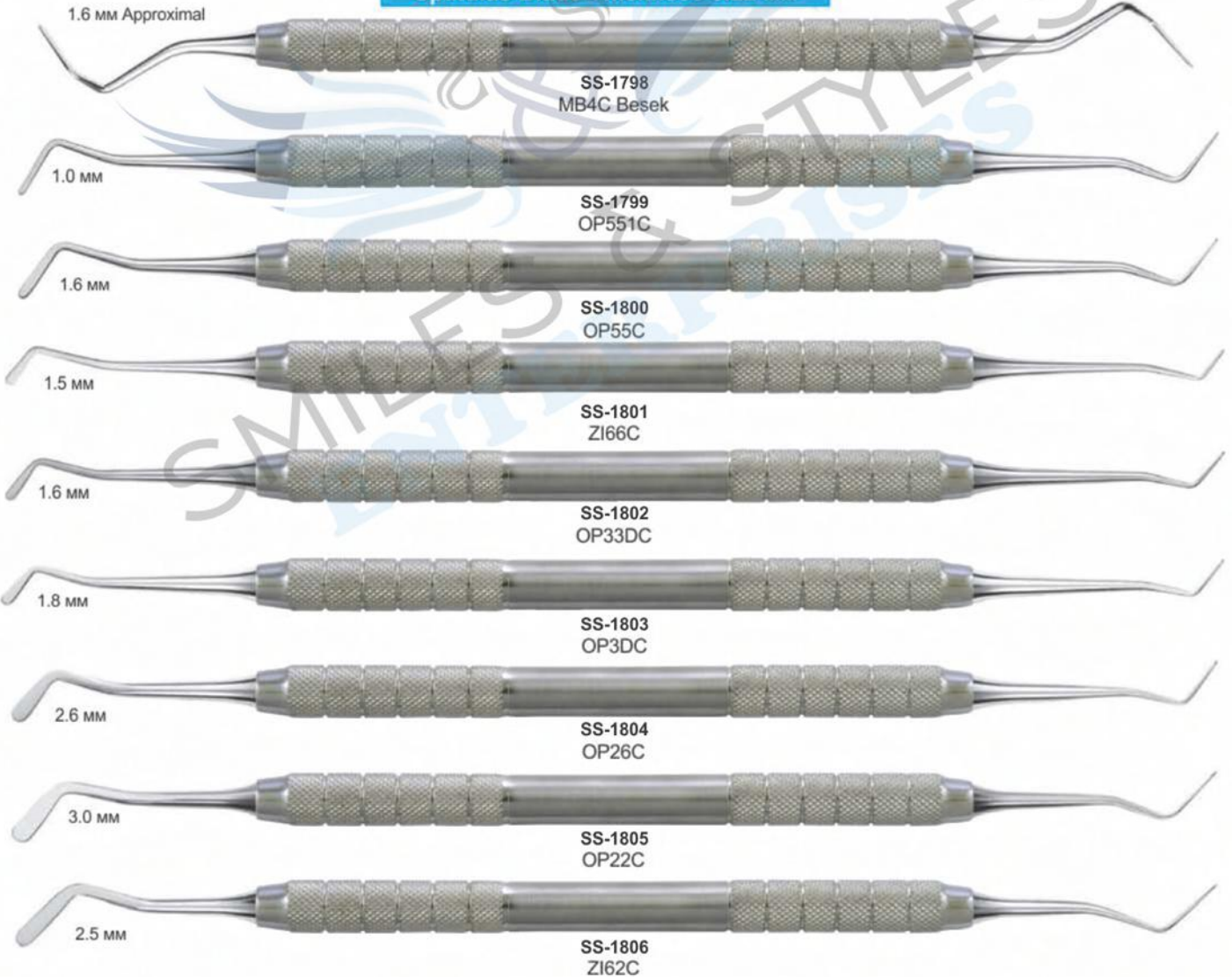

# COMPOSITE INSTRUMENTS

## Spatulas



## Spatulas-Pluggers





## EXCAVATOR INSTRUMENTS

Water drop Our excavators have particularly sharp blades, free of burrs and perfectly rounded.

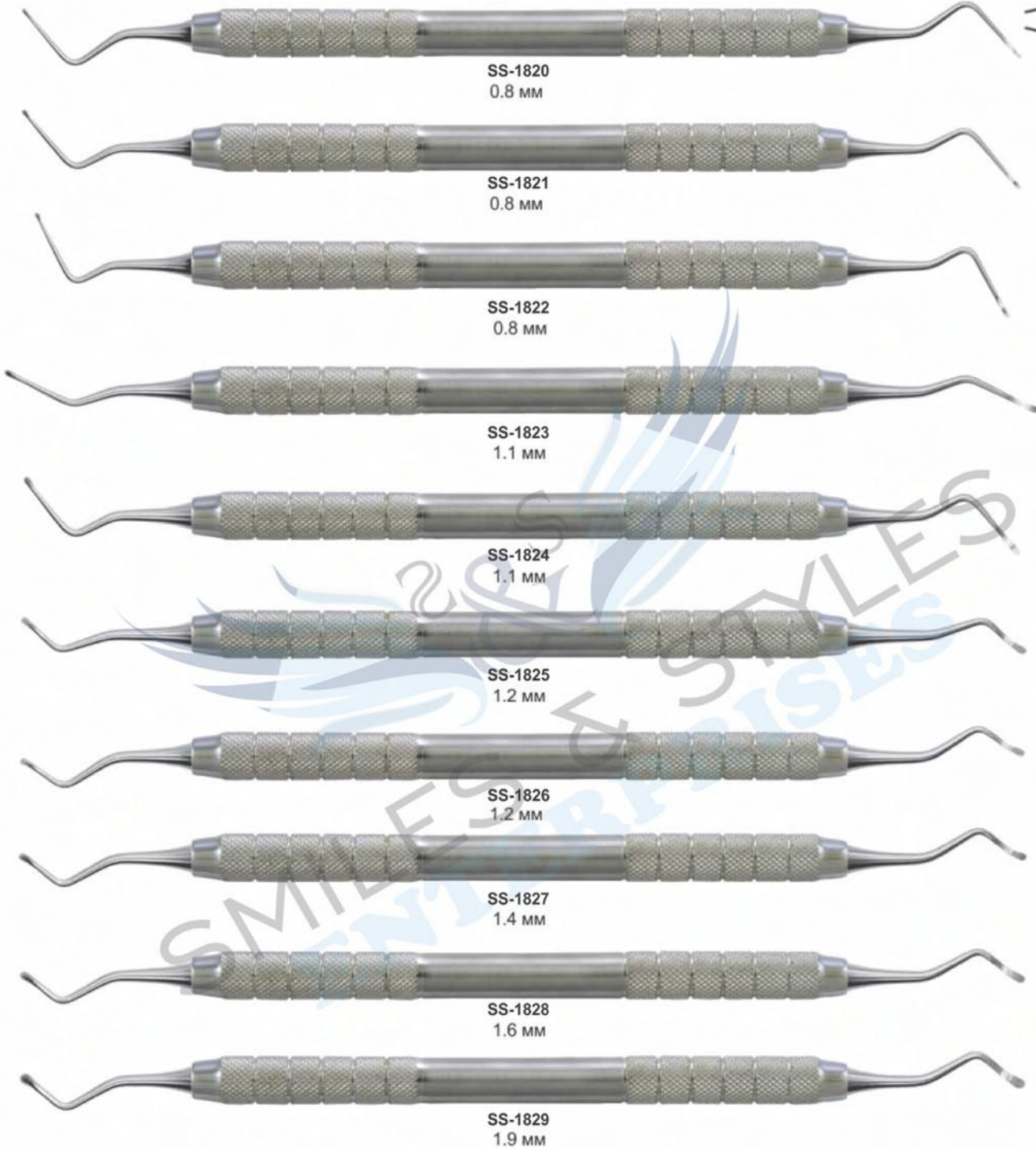

# FILLING INSTRUMENTS CONSERVATIVE TREATMENT

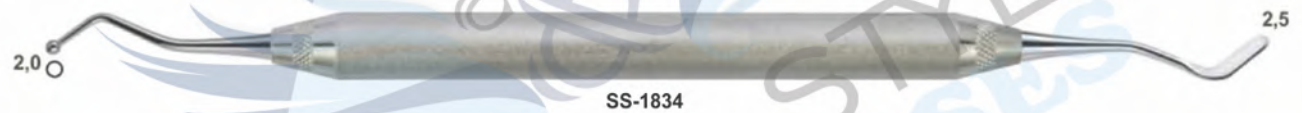
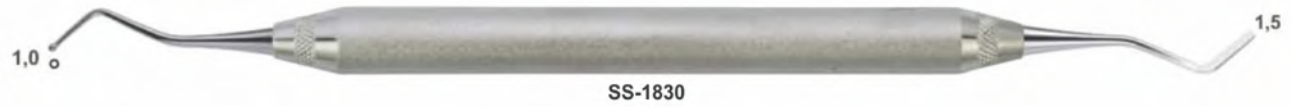



## COMPOSITE BALL PLUGGERS



# FILLING INSTRUMENTS CONSERVATIVE TREATMENT





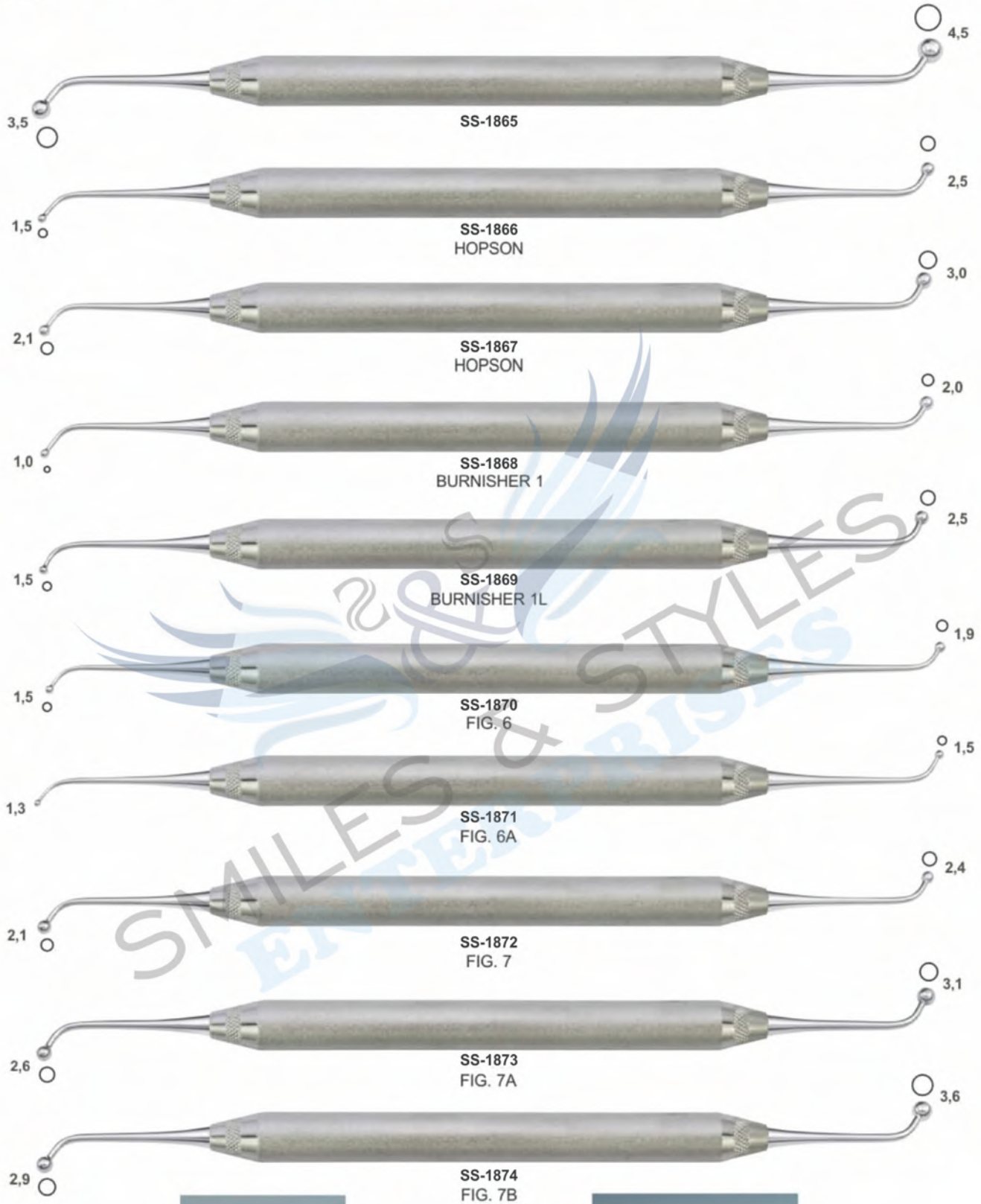

# FILLING INSTRUMENTS CONSERVATIVE TREATMENT





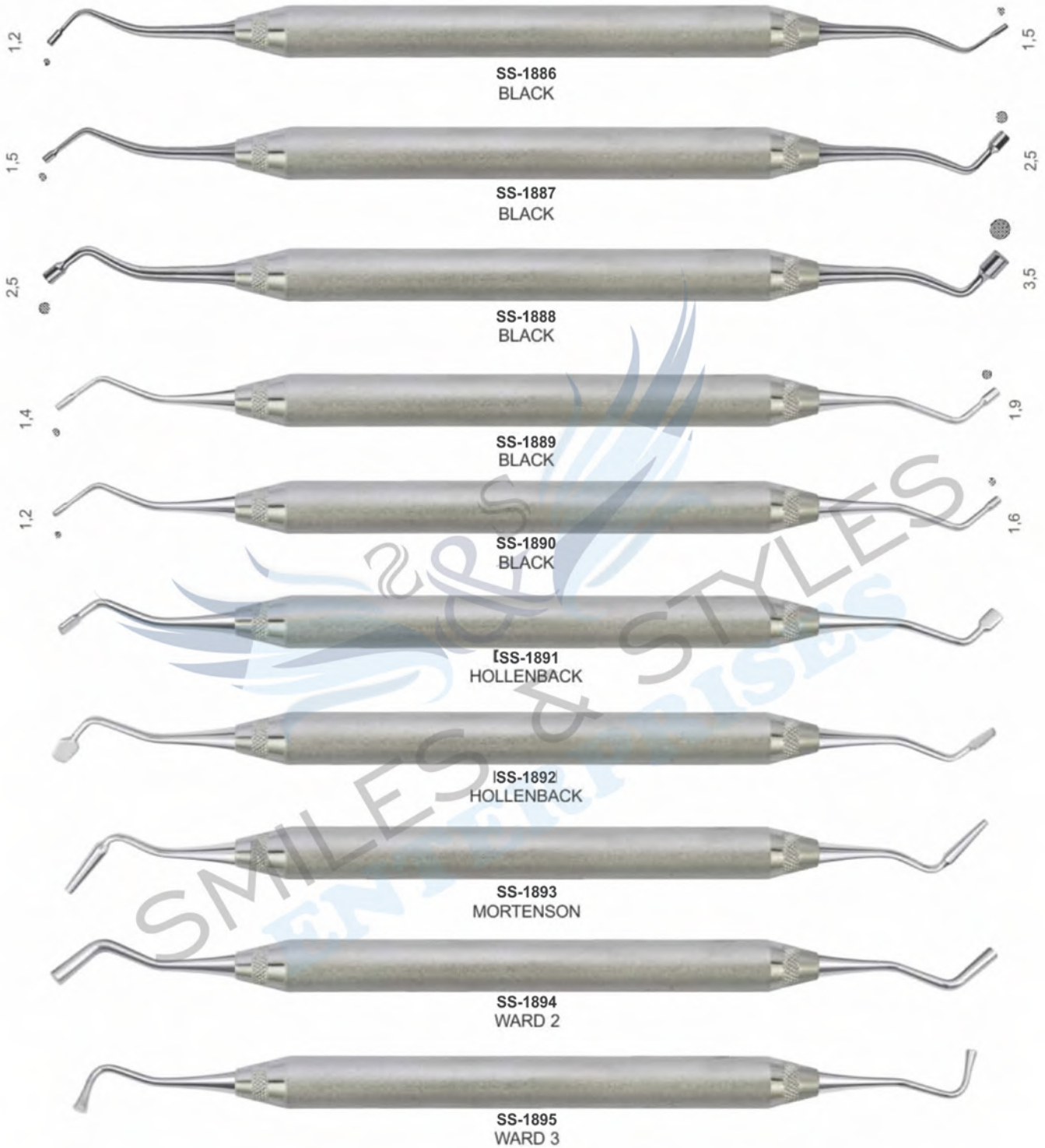

# FILLING INSTRUMENTS CONSERVATIVE TREATMENT



SS-1896  
WILLIAMS



SS-1897  
WILLIAMS



SS-1898  
WILLIAMS



SS-1899



SS-1900



SS-1901



SS-1902



SS-1903



SS-1904



SS-1905



## COMPOSITE PLUGGERS INSTRUMENTS



# COMPOSITE PLUGGERS INSTRUMENTS





Serrated Pluggers



Ø 0.9 MM		SS-1925 OP36M	Ø 1.2 MM
Ø 1.1 MM		SS-1926 OP36D	Ø 1.6 MM
Ø 1.6 MM		SS-1927 Op36	Ø 2.2 MM
Ø 1.0 MM		SS-1928 Op52	Ø 1.7 MM
Ø 2.2 MM		SS-1929 Zi51	Ø 2.6 MM
Ø 1.8 MM		SS-1930 Op44	Ø 2.2 MM
Ø 1.7 MM		SS-1931 1BR2	Ø 2.6 MM
Ø 2.6 MM		SS-1932 2BR3	Ø 3.6 MM



# COMPOSITE MODELLING INSTRUMENTS



SS-1933 MF2C  
Fuzzi



SS-1934  
Pj4



SS-1935 MB3C  
Besek



SS-1936  
HZ3C



SS-1937  
CPRO3C



SS-1938 Mo1  
Monari



SS-1939 TH28C  
Hirt



SS-1940  
HZ25C



SS-1941  
Ck10



SS-1942  
CK28BC



SS-1943 Op37  
Carver



SS-1944  
28BR29



Round excavators

- Cariology  
 - for the removal of softened, carious dentin  
 - for the removal of temporary fillings
- Surgery  
 - to sever the periodontal ligament prior to extraction  
 - for the removal of granulation tissue after extraction
- Design: Round working end Curved cutting edge



Round Excavator, 1.0 mm  
SS-1945



Round Excavator, 1.5 mm  
SS-1946



Round Excavator, 2.0 mm  
SS-1947

Triple-angled back action excavators



Triple-angled Back Action Excavator, 1.0 mm  
SS-1948



Triple-angled Back Action Excavator, 1.5 mm  
SS-1949



Triple-angled Back Action Excavator, 2.0 mm  
SS-1950



Triple-angled Back Action Excavator, 3.5 mm  
SS-1951



# FILLING INSTRUMENTS

- Инструменты для реставрации
- Instruments pour plombage
- Füllungsinstrumente (mit Kontrawinkel)
- Инструменти для реставрації
- Instrumentos para obturaciones
- ملء الصكوك

COMPOSITE/PLASTIC FILLING INSTRUMENTS SOLID HANDLE 6MM, LENGTH 170MM

BLACK

PLUGGERS/CONDENSERS

Hollenback

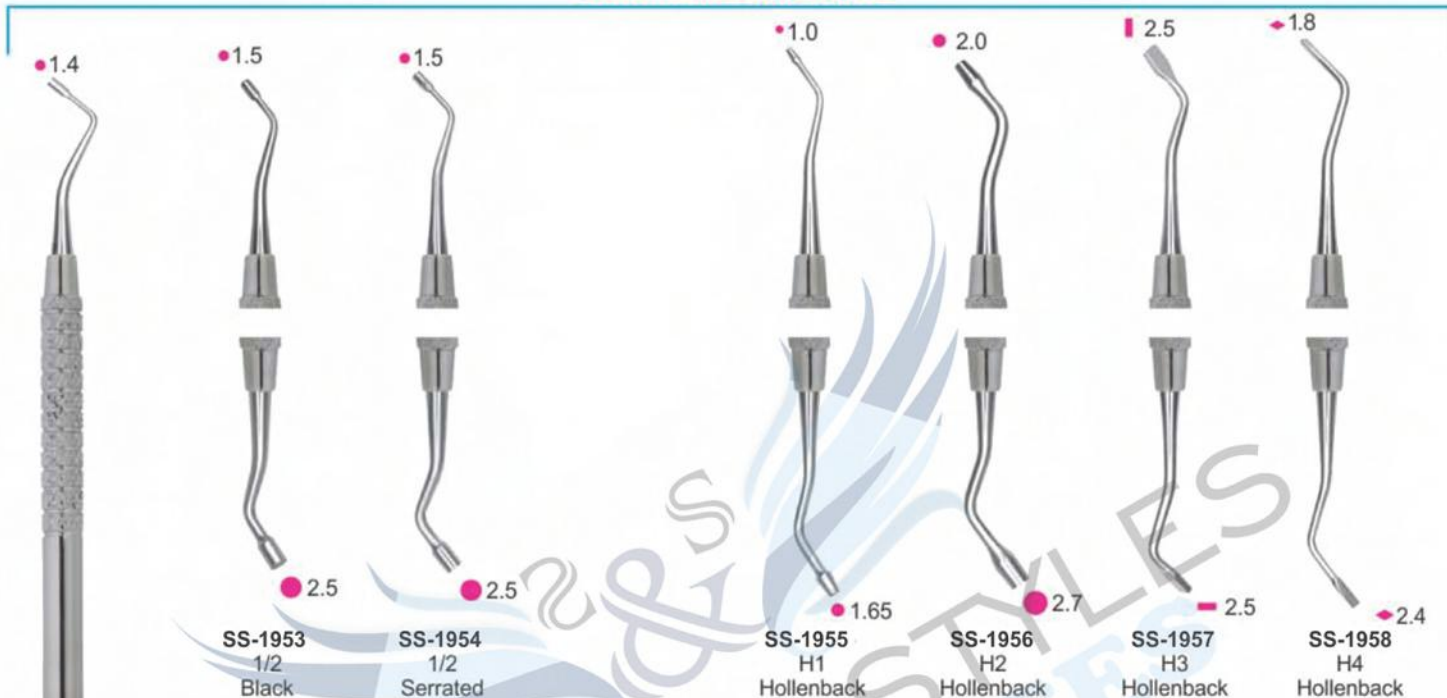

MARQUETTE CONDENSER

MORTONSON

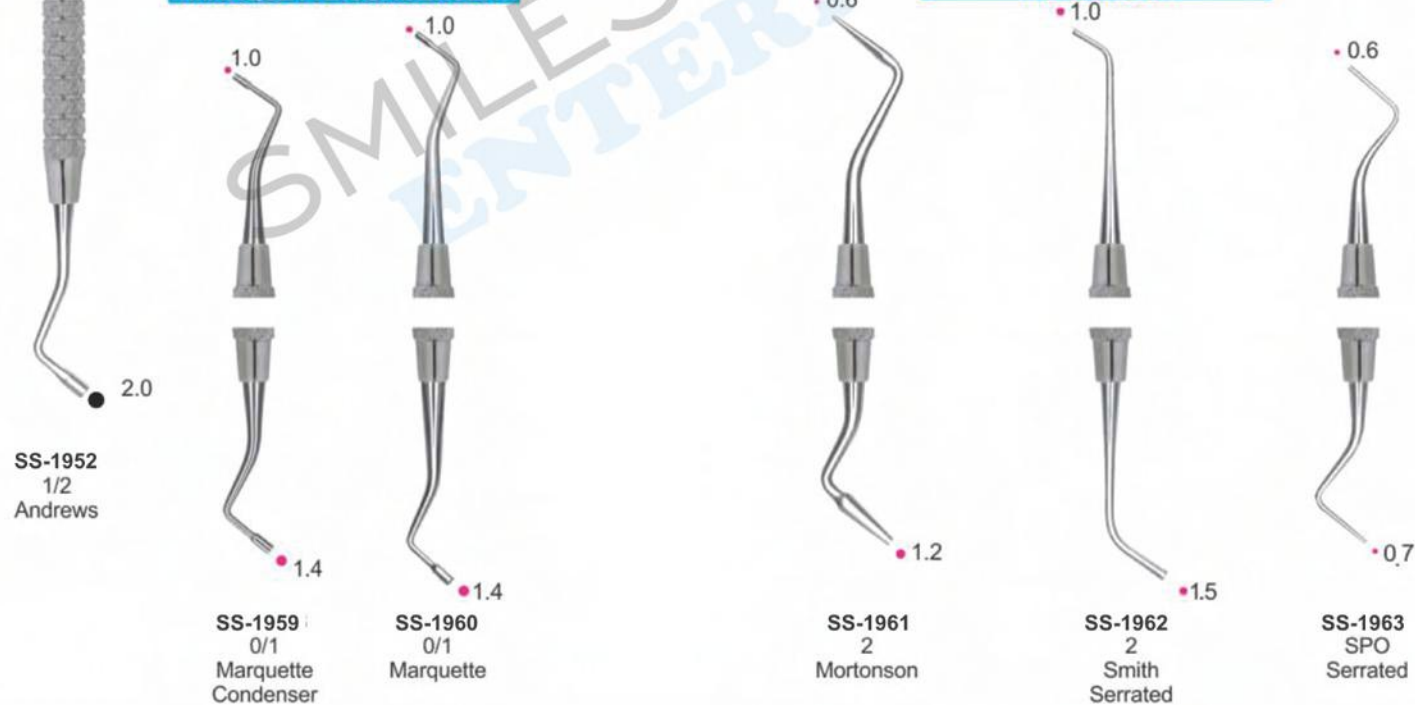



## FILLING INSTRUMENTS

- Инструменты для реставрации
- Instruments pour plombage
- Füllungsinstrumente (mit Kontrawinkel)
- Инструменти для реставрації
- Instrumentos para obturaciones
- ملء الصكوك

### RESTORATIVE INSTRUMENTS SOLID HANDLE 6MM, LENGTH 170MM Back Action Filling Instruments

#### Tanner Filling Instruments

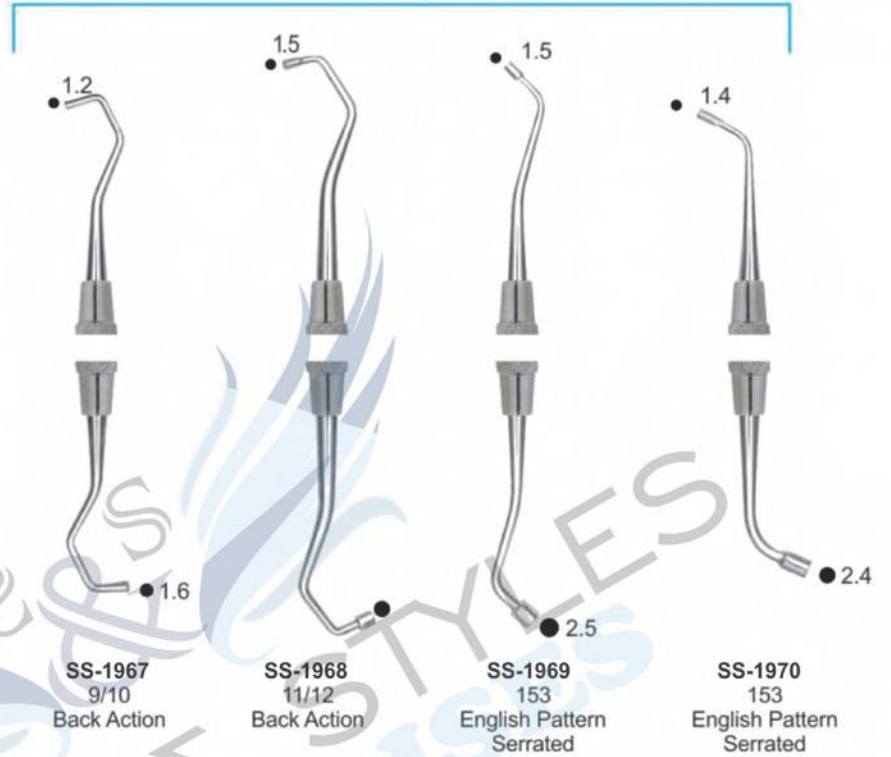
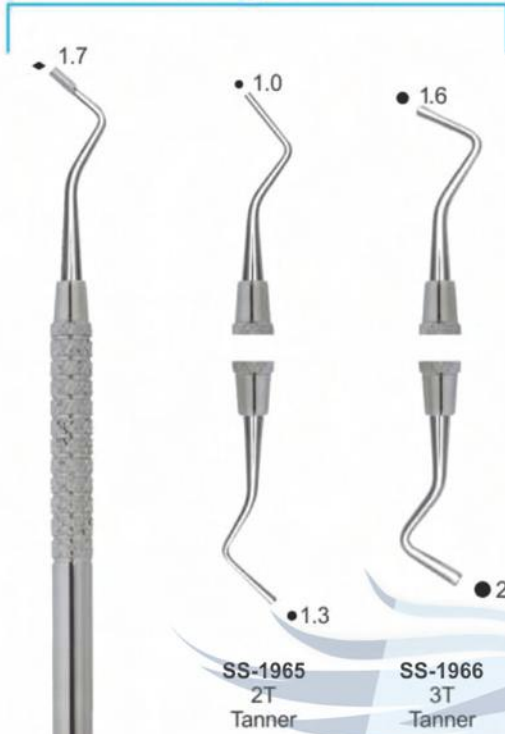

#### BALL

#### BURNISHERS

#### BEAVERTAIL

#### ACORN

#### LADMORE

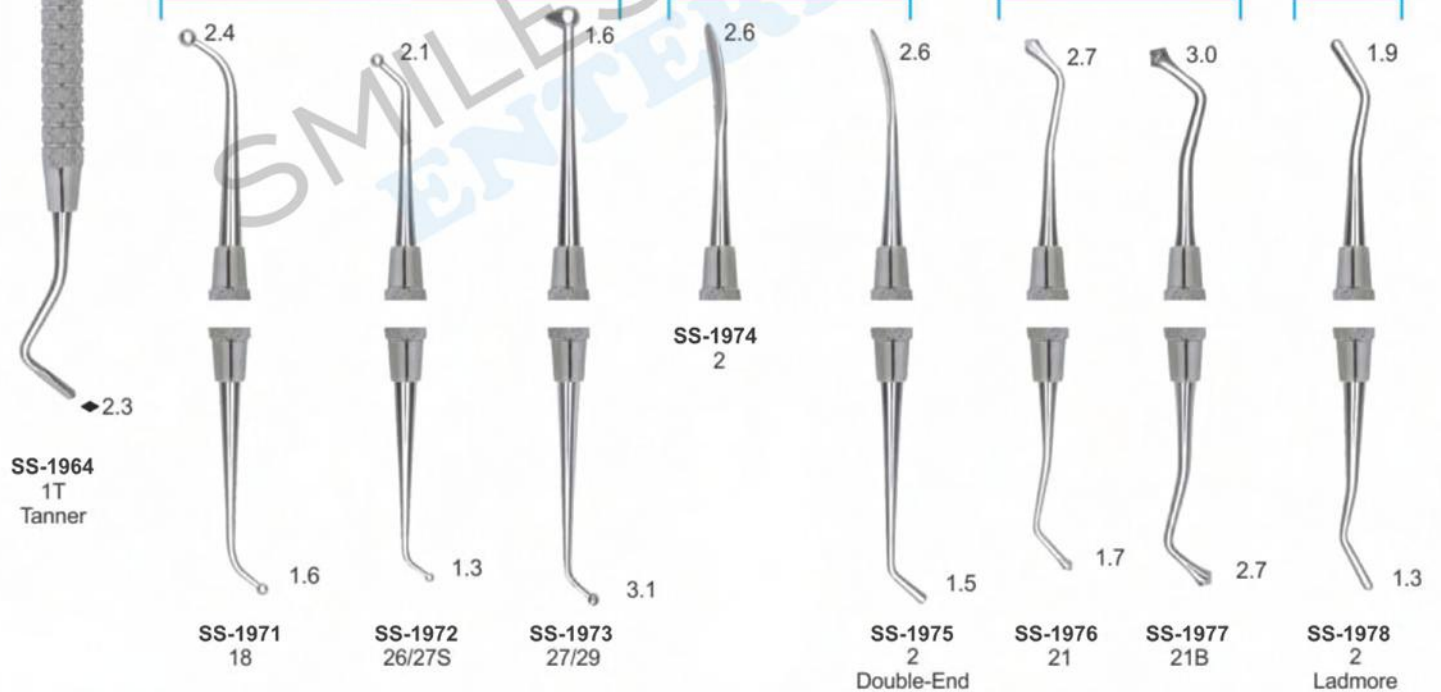

## CARVERS INSTRUMENTS

- Инструменты для реставрации
- Instruments a modeler
- Modellierinstrumente
- Инструменти для реставрації
- Instrumentos para modelar
- أدوات تقطيع

### P.K. THOMS WAXING INSTRUMENTS SOLID HANDLE 6mm



SS-1985  
Composite Instruments Blue  
Titanium with Cassettes



SS-1986  
P.k. Thomas Waxing Instruments Kit

### COMPOSITE INSTRUMENTS TITANIUM BLUE ENDODONTIC

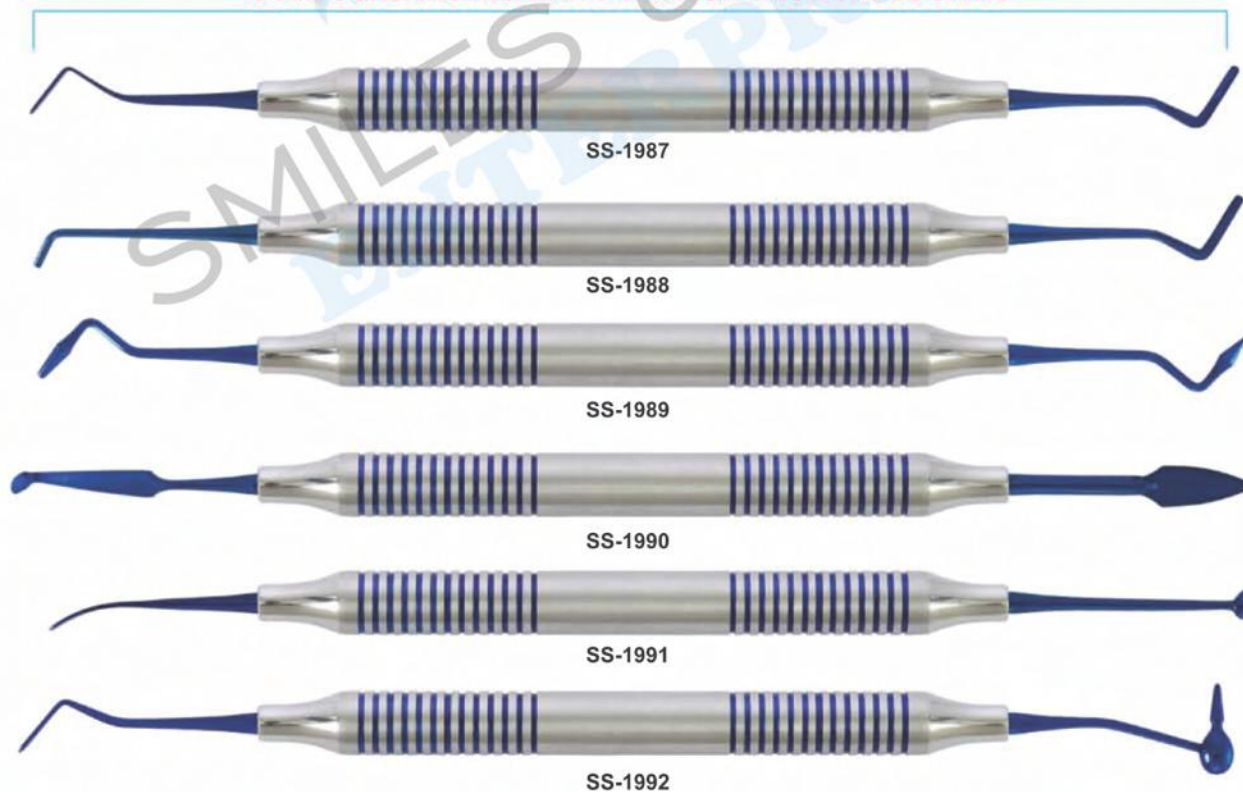



## CARVERS INSTRUMENTS

- Инструменты для реставрации
- Instruments a modeler
- Modellierinstrumente
- Инструменти для реставрації
- Instrumentos para modelar
- أدوات تقطيع



SS-1993



SS-1994



SS-1995



SS-1996



SS-1997



Cassette For 5 Instruments  
SS-1998

## FILLING INSTRUMENTS

- Инструменты для реставрации
- Instruments pour plombage
- Füllungsinstrumente (mit Kontrawinkel)
- Инструменти для реставрації
- Instrumentos para obturaciones
- ملء الصكوك

### FILLING INSTRUMENTS (Gold Pointed) SOLID HANDLE 6MM, LENGTH 170MM





## COMPOSITE FILLING INSTRUMENTS

- Инструменты для реставрации
- Instruments pour plombage
- Füllungsinstrumente (mit Kontrawinkel)
- Інструменти для реставрації
- Instrumentos para obturaciones
- ملء الصكوك



SS-2009

SS-2010

SS-2011

SS-2012

SS-2013

SS-2014

SS-2015

SS-2016

SS-2017

# COMPOSITE FILLING INSTRUMENTS

- Инструменты для реставрации
- Instruments pour plombage
- Füllungsinstrumente (mit Kontrawinkel)
- Инструменти для реставрації
- Instrumentos para obturaciones
- ملء الصكوك

## Composite Gold Tip Instruments

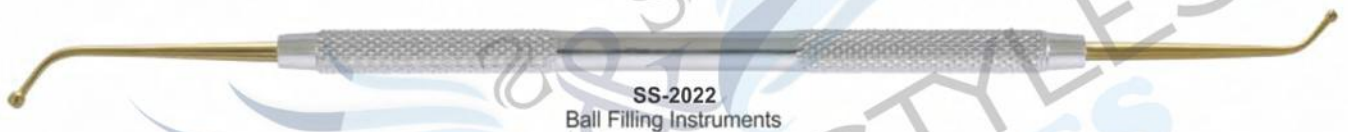



## MISCELLANEOUS PRODUCTS

- Прочие товары
- Divers produits et services
- Sonstige Produkte
- Інші товари
- Varios Productos
- المنتجات المتنوعة

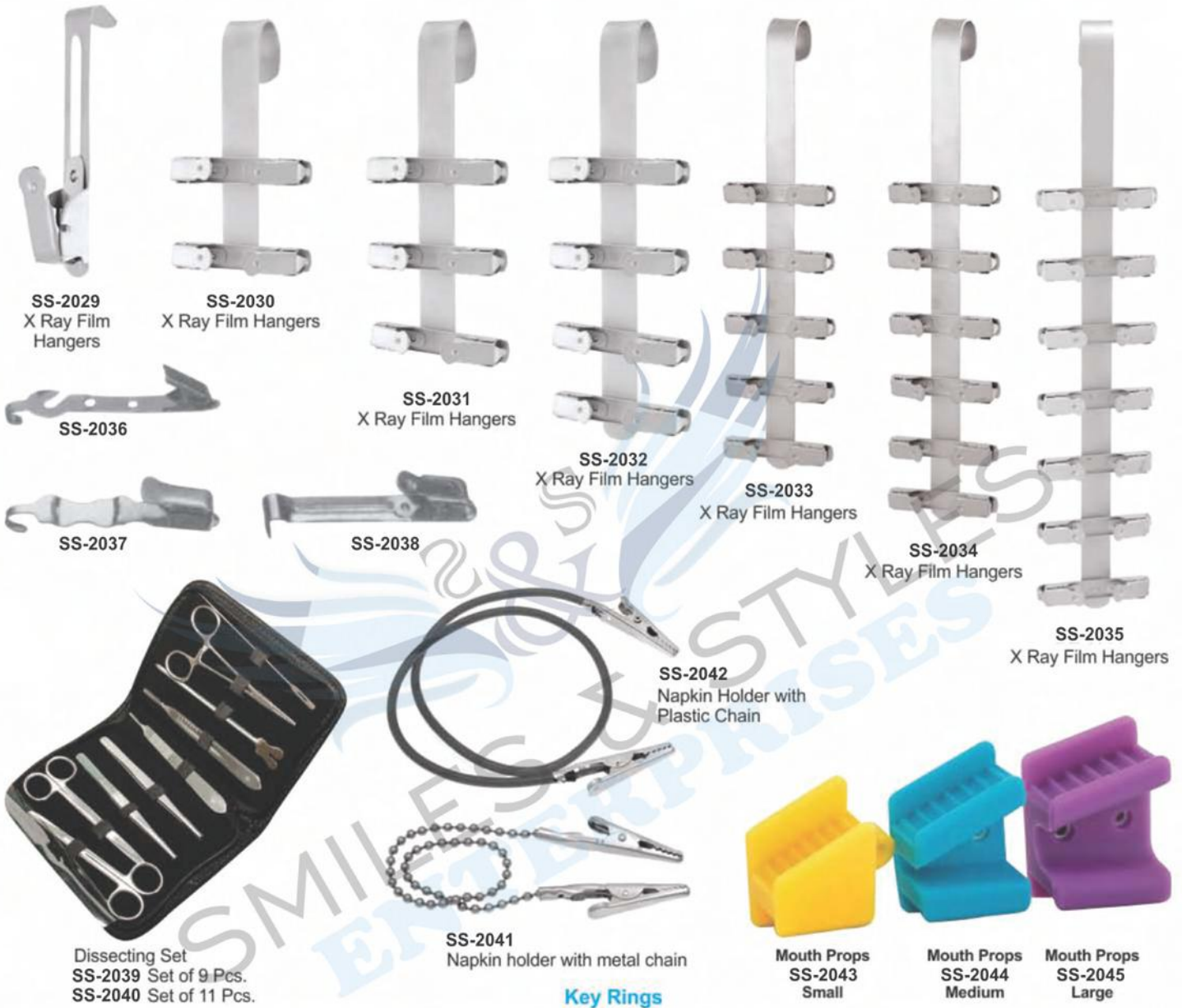

**SS-2029**  
X Ray Film Hangers

**SS-2030**  
X Ray Film Hangers

**SS-2031**  
X Ray Film Hangers

**SS-2032**  
X Ray Film Hangers

**SS-2033**  
X Ray Film Hangers

**SS-2034**  
X Ray Film Hangers

**SS-2035**  
X Ray Film Hangers

**SS-2036**

**SS-2037**

**SS-2038**

**SS-2042**  
Napkin Holder with Plastic Chain

**SS-2041**  
Napkin holder with metal chain

**Mouth Props**  
**SS-2043**  
Small

**Mouth Props**  
**SS-2044**  
Medium

**Mouth Props**  
**SS-2045**  
Large

**Dissecting Set**  
**SS-2039** Set of 9 Pcs.  
**SS-2040** Set of 11 Pcs.

### Key Rings



**SS-2046**

**SS-2047**

**SS-2048**

**SS-2049**

**SS-2050**

**SS-2051**

## CEMENT SPATULAS

- Шпатели для цемента
- Spatules à ciment
- Zementspatel
- Шпателі для цементу
- Espátulas para cemento
- ملاعق الاسمنت





## WAX KNIVES

- Ножи для воска
  - Couteaux a cire
  - Wachsmesser
- Ножі для воску
  - Cuchillos para cera
  - السكاكين الشمع

ALGINATE, PLASTER SPATULAS, WAX KNIVES PLASTER FOR KNIVES & PLASTER SHEAR



**SS-2074**  
Wooden Handle  
Fig. 5  
21.5 cm



**SS-2075**  
Wooden Handle  
Fig. 7  
19.5 cm curved



**SS-2076**  
Wooden Handle  
Fig. 8  
20 cm curved



**SS-2077**  
Wooden Handle  
Fig. 9  
22.5 cm curved



**SS-2078**  
Hook Knives



**SS-2079**  
Fig. 1  
Lessmann  
12.5 cm



**SS-2080**  
Fig. 2  
Lessmann  
17 cm



**SS-2081**  
Fig. 1  
with small spoon  
12.5 cm



**SS-2082**  
Fig. 2  
with large spoon  
17 cm



**SS-2083**  
Bacolite Handle  
Wax Knives,  
Small



**SS-2084**  
Bacolite Handle  
Wax Knives,  
Large



**SS-2085**  
Wooden Handle  
Wax Knives,  
Small



**SS-2086**  
Wooden Handle  
Wax Knives,  
Large



**SS-2087**  
Plaster Knife



**SS-2088**  
Fig. 1  
17 cm



**SS-2089**  
Fig. 3  
16 cm



**SS-2090**  
Fig. 4  
16 cm



**SS-2091**  
Special Inox  
19.5 cm

# ARTICULATORS

- Артикуляторы
- Artocilar
- Artikulations

- Артикулятори
- Articuler
- آرتیکولاتورس



SS-2092

**Technical Datas:**

Intercondylar distance	120 mm.
condylar inclination	fixed at 30°
Bennet angle	fixed at 7°
Incisal table inclination	10°
Distance between mounting plates	85 mm.
Weight	400 gr.
Opening (item 5000)	125°
Opening (item 5010)	180°



SS-2093

**Technical Datas:**

Intercondylar distance	110 mm.
condylar inclination	fixed at 30°
Bennet angle	fixed at 7°
Incisal table inclination	flat
Distance between mounting plates	85 mm.
Weight	450 gr.
Opening	180°



SS-2094

Stainless Steel Finishing  
SS-2095  
Royal Blue



SS-2096



SS-2097



SS-2098



SS-2099



SS-2100



SS-2101



SS-2102



SS-2103



SS-2104



SS-2105  
Nakawalni  
Dental Laboratory  
Instrument



# DENTAL PHOTOGRAPHIC MIRRORS

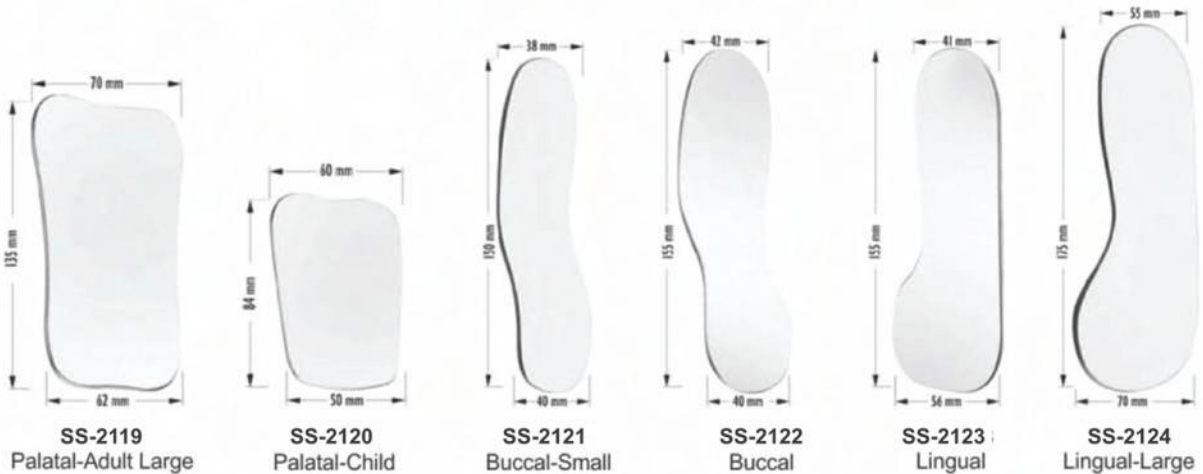
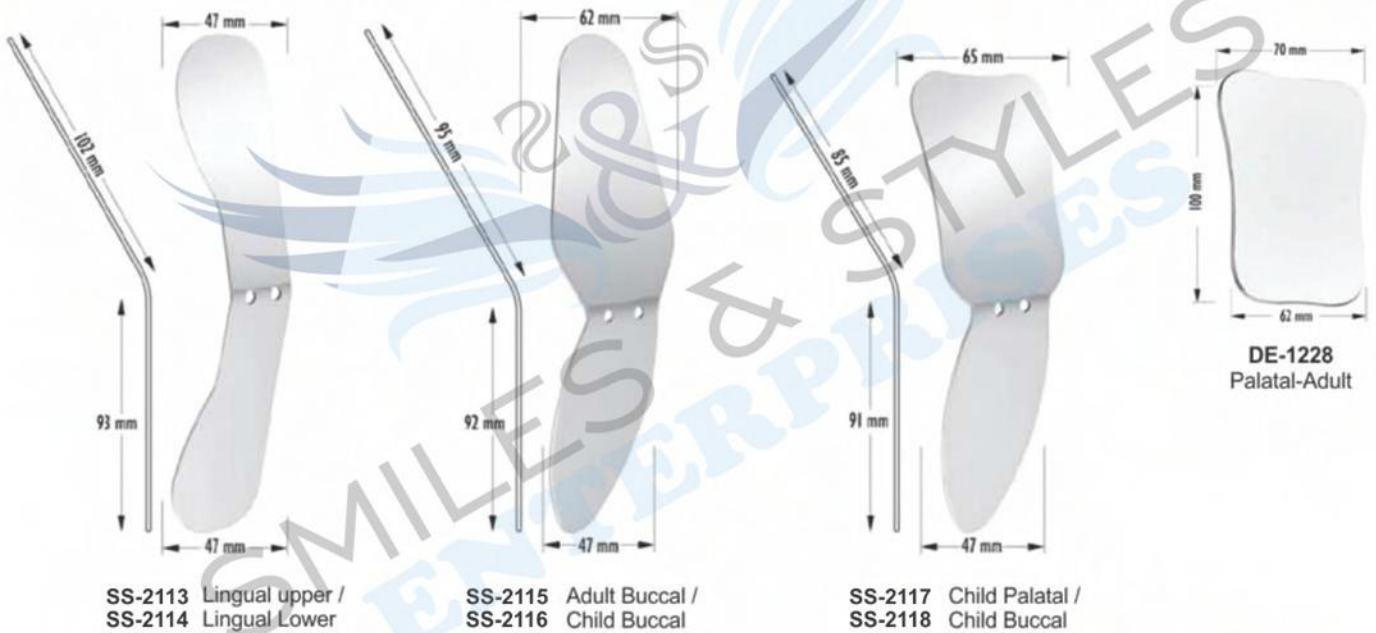
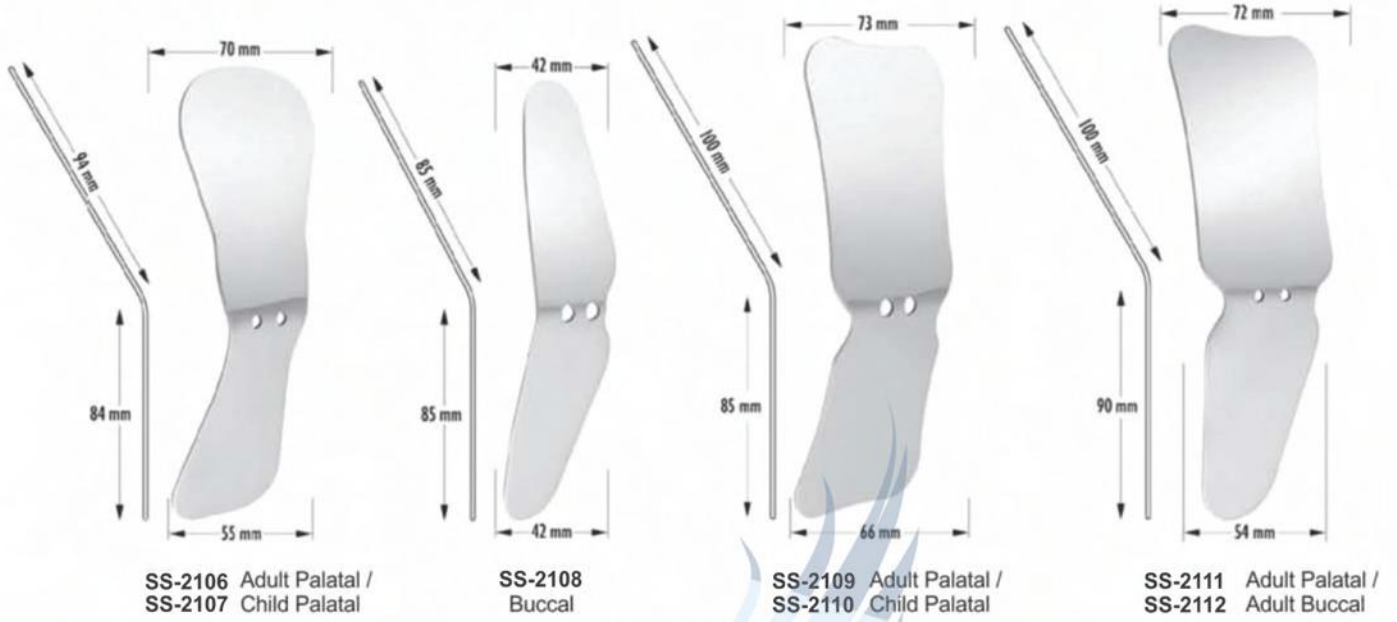

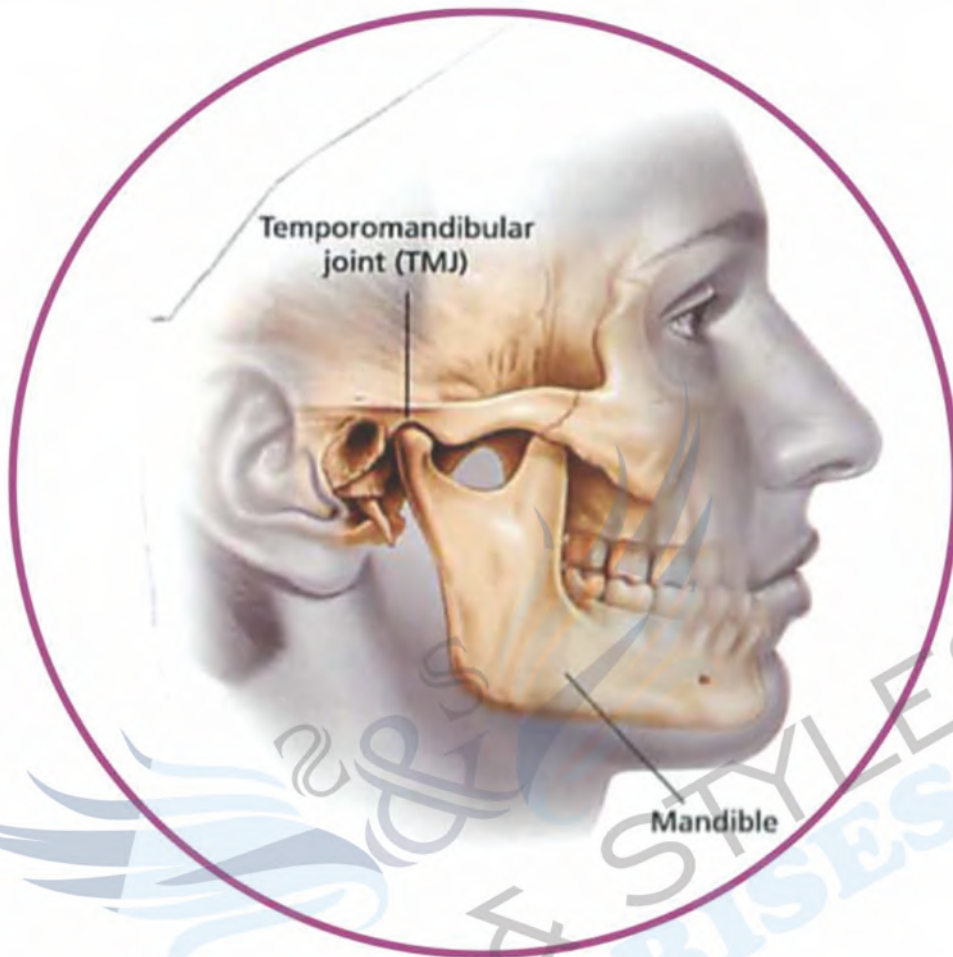



## RETRACTORS - MOUTH GAGS

- Роторасширители
- Ecarteurs - Ouvre-bouches
- Vestibulumabhalter / Mundspanner
- Роторозширювачі
- Separadores - Abre-bocas
- الكاشطات - الكمامات الفم



SS-2125  
HMG  
Heister  
130mm



SS-2126  
Mouth Gag Molt  
11 cm for (Children)



SS-2127  
Mouth Gag Molt  
14 cm for (Adults)



Sternberg Retractors  
SS-2128 140 mm  
SS-2129 180 mm



Columbia Retractor  
SS-2130 140 mm



SS-2131  
Wangen Holder  
vestibule  
15 cm, with or without  
lip protection,



SS-2132  
Wangen Holder  
vestibule 15 cm, with  
or without lip protection



SS-2133  
Wangen Holder  
with dual  
function, 17 cm



Weider Retractor



SS-2134  
140 mm



SS-2135  
150 mm

# RETRACTORS - MOUTH GAGS

- Роторасширители
- Ecarteurs - Ouvre-bouches
- Vestibulumabhalter / Mundspanner
- Роторозширювачі
- Separadores - Abre-bocas
- الكاشطات - الكشطات الفم



Weitlaner  
Fig. 1  
SS-2136 10.5cm  
SS-2137 13.5cm



Weitlaner  
Fig. 2  
SS-2138 10.5cm  
SS-2139 13.5cm



SS-2140  
Lip & Cheek Retractor  
Stainless Steel  
Double Ended



SS-2141  
Simplex Retractor  
Stainless Steel  
Single Ended



Weitlander  
SS-2142 11cm  
SS-2143 13cm  
SS-2144 15cm



SS-2148  
Denhard  
12 cm



SS-2149  
Roser-König  
16 cm



SS-2150  
Roser-König  
19 cm



Jennings  
SS-2145 11cm  
SS-2146 13cm  
SS-2147 15cm



## RETRACTORS

- Ранорасширители
- Ecarteurs
- Wundhaken
- Ранорозширювачі
- Separadores
- الكاشحات

**Wound, Bendable**  
Retractor, individually or as saving kit!



**SS-2151**  
Cheek Retainer  
One-sided  
Long



**SS-2152**  
Cheek Retainer  
One-sided  
Long



**SS-2153**  
Cheek Retainer  
One-sided  
Long



**Ergo Grip  
Retractor**  
**SS-2154** 24 cm  
ergonomic handle,



**Ivory Retractors**  
Width adjustable  
& fixable,  
**SS-2155** 20 cm



**Bruenings Retractors**  
tongue depressors  
**SS-2156** 19 cm



**Minnesota  
Retractors**  
**SS-2157** 16 cm



**Ribbon Retractors**  
**SS-2158** 20 cm  
easy to bend  
by hand,



**Bishop Retractors**  
retractor and tongue  
pushers Bishop with  
comfortable margin  
**SS-2159** 16 cm



**Combination  
Retractors**  
**SS-2160** 25 cm

## RETRACTORS

- Ранорасширители
  - Ecarteurs
  - Wundhaken
- Ранорозширювачі
  - Separadores
  - الكاشطات



**SS-2161**  
Unique Retractors  
Length 175 mm  
angled 45°



**SS-2162**  
Unique Retractors  
Length 175 mm  
angled 90°



**SS-2163**  
Retractors  
16cm



**SS-2164**  
Retractors  
19cm



**SS-2165**  
Mini-Langenbeck  
Retractors  
16 cm, hooks 22 mm



**SS-2166**  
US Army Retractors  
21 cm, 2



**SS-2167**  
ALM Retractor  
about 8 cm



**SS-2168**  
Senn Mueller Retractor  
17 cm, hooks 22 mm



## RETRACTORS

- Ранорасширители
- Ecarteurs
- Wundhaken
- Ранорозширювачі
- Separadores
- الكاشحات



**SS-2169**  
Langenbeck Retractors  
surgical-flat  
21 cm, hook  
30x16 mm



**SS-2170**  
Langenbeck Retractors  
surgical-flat  
21 cm, hook  
42x11 mm



**SS-2171**  
Langenbeck Retractors  
surgical-flat  
21 cm, hook  
63x12 mm



Langenbeck Retractors  
surgical-flat  
21 cm, hook  
**SS-2172** 30x16 mm  
**SS-2173** 42x11 mm  
**SS-2174** 63x12 mm



Langenbeck Retractors  
21 cm, hook  
**SS-2175** 30x11 mm  
**SS-2176** 30x16 mm



**SS-2177**  
Middelborpf  
Retractors  
21 cm



**SS-2178**  
Farabeuf  
(120 X 12mm  
Set of 2 pices)



**SS-2179**  
Retractor Seldin



**SS-2180**  
Feldman Retractor  
14cm

## GUM SCISSORS

- Ножницы десневые
- Ciseaux a gencives
- Zahnfleischscheren

- Ножіці для ясен
- Tijeras para encias
- مقص صمغ



**SS-2181**  
Iris  
115mm  
Straight



**SS-2182**  
Iris  
115mm  
Curved



**SS-2183**  
Goldman-Fox  
130mm  
Saw edge, straight



**SS-2184**  
Goldman-Fox  
130mm  
Saw edge, Curved



**SS-2185**  
La Grange  
115mm  
Saw edge, double Curved



Mayo  
**SS-2186** 140mm  
**SS-2187** 170mm  
**SS-2188** 230mm  
Straight



Mayo  
**SS-2189** 140mm  
**SS-2190** 170mm  
**SS-2191** 230mm  
Curved



Metzenbaum  
**SS-2192** 145mm  
**SS-2193** 180mm  
**SS-2194** 200mm  
Straight



Metzenbaum  
**SS-2195** 145mm  
**SS-2196** 180mm  
**SS-2197** 200mm  
Curved



**SS-2198**  
Kelly  
160mm  
Straight



**SS-2199**  
Kelly  
160mm  
Curved



**SS-2200**  
Iris  
115mm  
Straight



**SS-2201**  
Iris  
115mm  
Curved



**SS-2202**  
La Grange  
115mm  
Double Curved



**SS-2203**  
Goldman-Fox  
130mm, Straight



**SS-2204**  
Goldman-Fox  
130mm, Curved



**SS-2205**  
Kelly  
160mm, Curved



**SS-2206**  
Iris  
115mm, Straight



**SS-2207**  
Iris  
115mm, Curved



**SS-2208**  
Micro Iris  
90mm, Curved



## GUM SCISSORS

- Ножницы десневые
- Ciseaux a gengives
- Zahnfleischscheren
- Ножіці для ясен
- Tijeras para encias
- مقص صغى



**SS-2209**  
Iris  
115mm  
Angled



**SS-2210**  
Iris  
115mm  
Curved



**SS-2211**  
Goldman-Fox  
130mm  
Saw edge,  
straight



**SS-2212**  
Goldman-Fox  
130mm  
Saw edge,  
curved



**SS-2213**  
Goldman-Fox  
130mm  
Saw edge,  
double curved



**SS-2214**  
La Grange  
115mm  
Saw edge,  
double curved



**SS-2215**  
Neumann  
120mm  
Saw edge,  
double curved



**SS-2216**  
Kilner (Ragnell)  
120mm  
Straight



**SS-2217**  
Kilner (Ragnell)  
120mm  
Curved



**SS-2218**  
Joseph  
140mm  
Straight



**SS-2219**  
Joseph  
140mm  
Curved



**SS-2220**  
Kelly  
160mm  
Straight



**SS-2221**  
Kelly  
160mm  
Curved



**SS-2222**  
Locklin  
160mm  
Saw edge,  
angular



**SS-2223**  
Locklin  
120mm  
**DE-1350**  
160mm  
Saw edge, angular



**SS-2224**  
Dean  
170mm  
Saw edge,  
angular



**SS-2225**  
Spencer  
90mm



**SS-2226**  
Spencer  
130mm



**SS-2227**  
Spencer  
115mm



**SS-2228**  
Noyes  
110mm, Straight



**SS-2229**  
Noyes  
110mm  
Curved



**SS-2230**  
Noyes  
110mm  
Angular



**SS-2231**  
Castroviejo  
150mm  
Curved

## GUM SCISSORS

- Ножницы десневые
- Ciseaux a gencives
- Zahnfleischscheren

- Ножіці для ясен
- Tijeras para encias
- مقص صمغ

## NEEDLE HOLDERS

- Иглодержатели
- Porte-aiguilles
- Nadelhalter

- Голкотримачі
- Porta-agujas
- اصحاب ابرة



SS-2232  
130mm  
Straight



SS-2233  
SS-2234  
SS-2235

Mayo Mayo  
130mm 130mm  
160mm 160mm  
180mm 180mm  
Straight Curved



SS-2236  
SS-2237

Mayo Mayo  
140mm 140mm  
200mm 200mm  
Straight Curved



SS-2238  
SS-2239

Metzenbaum  
145mm 145mm  
200mm 200mm  
Straight Curved



SS-2240  
Beebee  
110mm  
Saw edge,  
straight



SS-2241  
Beebee  
110mm  
Saw edge,  
curved



SS-2242  
Beebe  
110mm  
Saw edge, straight



SS-2243  
Beebe  
110mm  
Saw edge, curved



SS-2244  
Universal  
120mm  
Saw edge



SS-2245  
Universal  
120mm



Ryder  
SS-2246 130mm  
SS-2247 150mm  
SS-2248 180mm



SS-2249  
Halsey  
130mm



SS-2250  
Baumgartner  
130mm



SS-2251  
Derf  
120mm



SS-2252  
Delicate  
150mm



Mayo-Hegar  
SS-2253 130mm  
SS-2254 160mm  
SS-2255 180mm  
SS-2256 200mm



SS-2257  
Crile-Wood  
150mm  
straight



SS-2258  
Crile-Wood  
150mm  
curved



## NEEDLE HOLDERS

- Иглодержатели
- Porte-aiguilles
- Nadelhalter

- Голкотримачи
- Porta-agujas
- اصحاب ابرة



Ryder  
SS-2259 130mm  
SS-2260 150mm  
SS-2261 180mm



SS-2262  
Halsey  
130mm



SS-2263  
Baumgartner  
130mm



SS-2264  
Derf  
120mm



SS-2265  
Delicate  
150mm



SS-2266  
Adson  
170mm



Mayo-Hegar  
SS-2267 130mm  
SS-2268 160mm  
SS-2269 180mm  
SS-2270 200mm



SS-2271  
Crile-Wood  
150mm



Castroviejo  
SS-2272 str 140mm cvd  
SS-2273 str 180mm cvd



Olsen-Hegar Needle  
Holder With Scissors  
SS-2274 140mm



Gillies Needle  
Holder With Scissors  
SS-2275 160mm



Mathieu  
SS-2276 140mm  
SS-2277 170mm



Castroviejo  
SS-2278 str 140mm cvd  
SS-2279 str 180mm cvd



Olsen-Hegar Needle  
Holder With Scissors  
SS-2280 140mm



Gillies Needle  
Holder With Scissors  
SS-2281 160mm

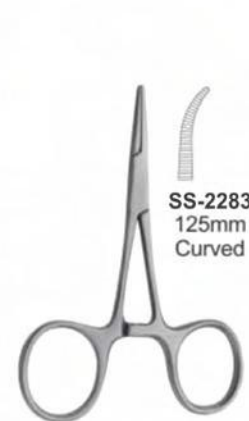

Hartmann (Baby  
Mosquito)  
SS-2282 90mm straight  
SS-2283 125mm  
Curved



Halstead Mosquito  
SS-2284 125mm  
Straight  
SS-2285  
Curved

## GUM SCISSORS

- Ножницы десневые
- Ciseaux a gencives
- Zahnfleischscheren
- Ножці для ясен
- Tijeras para encias
- مقص صمغ



**SS-2286**  
Goldman Fox Scissors  
12.5cm Curved



**SS-2287**  
Iris Scissors  
11.5cm Curved  
Serrated For Slip-Free Cutting



**SS-2288**  
LaGrange Scissors  
11.5cm Double Curved  
Serrated For Slip-Free Cutting

Double  
Curved



**SS-2289**  
Castroviejo Micro Scissors  
12cm Curved



**SS-2290**  
Super Cut Goldman Fox  
13.2cm Curved  
Serrated For Slip-Free Cutting



**SS-2291**  
Super Cut Iris  
11cm Straight  
Serrated For Slip-Free Cutting



**SS-2292**  
Super Cut Iris  
11cm Curved  
Serrated For Slip-Free Cutting



**SS-2293**  
Super Cut LaGrange  
11.5cm  
Double Curved  
Serrated For Slip-Free Cutting

Double  
Curved



## NEEDLE HOLDERS

- Иглодержатели
- Porte-aiguilles
- Nadelhalter

- Голкотримачи
- Porta-agujas
- اصحاب ابرة



SS-2294  
Lichtenberg-  
Ryder T.C  
14 cm



SS-2295  
Lichtenberg-  
Ryder T.C  
14 cm



SS-2296  
Lichtenberg-  
Ryder T.C  
17 cm



SS-2297  
Lichtenberg-  
Ryder T.C  
17 cm



SS-2298  
Barraquer  
18 cm



SS-2300  
Barraquer T.C  
18 cm



SS-2299  
Barraquer  
18 cm



SS-2301  
Barraquer T.C  
18 cm



SS-2302  
Tönnis  
18 cm



SS-2303  
Castroviejo  
13 cm  
Straight



SS-2304  
Kalt Needle Holders T.C  
14 cm Straight



SS-2305  
Peet Splinter Forceps  
11.5 cm

SS-2306  
La Grange  
Curved



SS-2307  
All-Purpose Pliers

# HAEMOSTATIC FORCEPS & TOWEL CLAMPS

- Зажимы артериальные, зажимы для салфеток
- Pincas hemostatiques, Pincas a compresas
- Arterienklemmen, Tuychklemmen
- Затиски артериальні, затиски для серветок
- Pinzas hemostaticas, Pincas para compresas
- الملقط هايموستاتيک المشابک منشفة

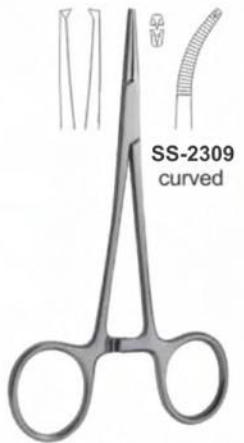

Halstead Mosquito 1x2  
SS-2308 125mm  
straight

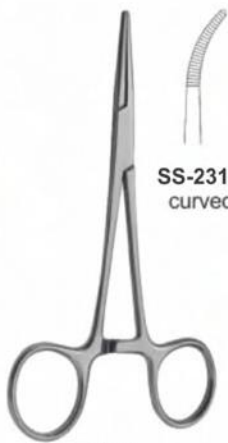

Kelly  
SS-2310 140mm  
straight

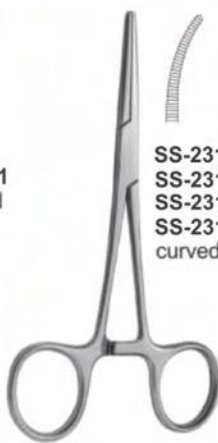

Rochester-Pean  
SS-2311 140mm  
SS-2312 160mm  
SS-2313 180mm  
SS-2314 200mm  
straight



Rochester-Kocher 1x2  
SS-2319 140mm  
SS-2320 160mm  
SS-2321 180mm  
SS-2322 200mm  
straight



SS-2327  
Kelly-Rankin  
160mm  
straight



Lorna  
SS-2329 100mm  
SS-2330 130mm



SS-2331  
Allis-Baby 3:4  
150mm



SS-2332  
Allis 4:5  
200mm



SS-2333  
Allis 6:7  
200mm



Ball Socket  
SS-2334 140mm  
Not-perforating and  
not-damaging



SS-2335  
Backhaus  
130mm



SS-2336  
Backhaus  
85mm



SS-2337  
Jones  
90mm

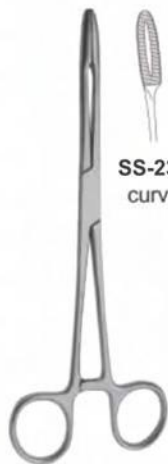

Gross Maier  
Dressing Forceps  
SS-2338 200mm straight



Foerster  
Dressing Forceps  
SS-2340 200mm



Young  
Tongue Forceps  
SS-2341 170mm



Collins  
Tongue Forceps  
SS-2342 170mm



## RUBBER DAM CLAMPS FORCEPS

- Инструменты для системы коффердам
- Pincas porte-crampons a digue
- Kofferdam Klammerzangen
- Инструменти для системи коффердам
- Pinzas de engrapar para dique de caucho
- السد العظام الملقط المشابه



### SS-2343

On request the Content of the rubber dam kit can be changed with other instruments.

#### Content:

- 01 Anisworth
- 02 Brewer
- 03 Clamps Stand
- 04 Denture Plate
- 05 Rubber Dam Frame
- 06 Rubber Dam Box Lower Case
- 07 Rubber Dam Box Upper Case
- 08 Rubber Dam Clamp Fig. 212
- 09 Rubber Dam Clamp Fig. 211
- 10 Rubber Dam Clamp Fig. 8
- 11 Rubber Dam Clamp Fig. 8A
- 12 Rubber Dam Clamp Fig. 14
- 13 Rubber Dam Clamp Fig. 14A
- 14 Rubber Dam Clamp Fig. 0
- 15 Rubber Dam Clamp Fig. 00
- 16 Rubber Dam Clamp Fig. 2
- 17 Rubber Dam Clamp Fig. 2A
- 18 Rubber Dam Clamp Fig. 7

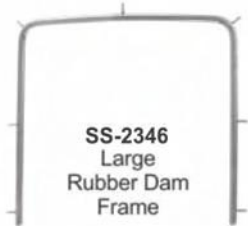
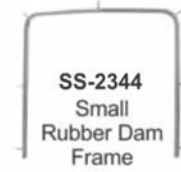

SS-2347  
Brewer



SS-2348  
Stockes



SS-2349  
Palmer



SS-2350  
Ivory light weight



SS-2351  
Anisworth



SS-2352  
Anisworth



SS-2353  
Anisworth



SS-2354  
Ivory



SS-2355  
Separating  
Elastic Plier

## RUBBER DAM CLAMPS KITS

- Резиновая дамба зажимы комплекты
- Trousses de caoutchouc
- Gummidammklammern
- Гумова дамба затискачі комплекти
- Conjuntos de abrazaderas de retención de caucho
- المطاط السد المشابك مجموعات



**SS-2356**

Stainless Steel Gold Plated Rubber Dam Clamp Tray with 11 Different Clamps  
Fig. 212, 211, 8, 8A, 14, 14A, 0, 00, 2, 2A, 7



**SS-2357**

Stainless Steel Rubber Dam Clamp Tray with 12 Different Clamps  
Fig. 209, 212, 211, 8, 8A, 14, 14A, 0, 00, 2, 2A, 7



**SS-2358**

Stainless Steel Rubber Dam Clamp Tray with 8 Different Clamps  
Fig. 1, 26, 29, 51, 60, 202, 205, 210



**SS-2359**

Stainless Steel Rubber Dam Clamp Tray  
(without clamps)



**SS-2360**

On request the Content of the rubber dam kit can be changed with other instruments.

**Content:**

- 01 Ivory
- 02 Ivory light weight
- 03 Clamps Stand
- 04 Rubber Dam Frame M
- 05 Rubber Dam Frame L
- 06 Rubber Dam Box Lower Case
- 07 Rubber Dam Box Upper Case

- 08 Rubber Dam Clamp Fig. 209
- 09 Rubber Dam Clamp Fig. 212
- 10 Rubber Dam Clamp Fig. 211
- 11 Rubber Dam Clamp Fig. 8
- 12 Rubber Dam Clamp Fig. 8A
- 13 Rubber Dam Clamp Fig. 14
- 14 Rubber Dam Clamp Fig. 14A
- 15 Rubber Dam Clamp Fig. 0
- 16 Rubber Dam Clamp Fig. 00
- 17 Rubber Dam Clamp Fig. 2
- 18 Rubber Dam Clamp Fig. 2A
- 19 Rubber Dam Clamp Fig. 7

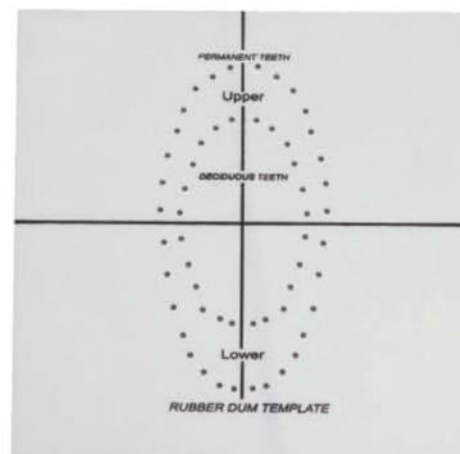

**SS-2361**  
Rubber Dum Template



## RUBBER DAM CLAMPS

- Кляммера для коффердама
- Crampons pour digue
- Kofferdam Klammern
- Кляммера для коффердама
- Grapas para dique de caucho
- المشابك السد المطاط



SS-2362  
Fig. 15



SS-2363  
Fig. 18



SS-2364  
Fig. 24



SS-2365  
Fig. 25



SS-2366  
Fig. 26



SS-2367  
Fig. 28



SS-2368  
Fig. 30



SS-2369  
Fig. 31



SS-2370  
Fig. 51



SS-2371  
Fig. 138



SS-2372  
Fig. 139



SS-2373  
Fig. 200



SS-2374  
Fig. 201



SS-2375  
Fig. 202



SS-2376  
Fig. 203



SS-2377  
Fig. 204



SS-2378  
Fig. 205



SS-2379  
Fig. 3



SS-2380  
Fig. W3



SS-2381  
Fig. 4



SS-2382  
Fig. 56A



SS-2383  
Fig. 7



SS-2384  
Fig. 7A



SS-2385  
Fig. 8



SS-2386  
Fig. 8A



SS-2387  
Fig. W8A



SS-2388  
Fig. 10



SS-2389  
Fig. 11



SS-2390  
Fig. 12A



SS-2391  
Fig. 13A



SS-2392  
Fig. 14



SS-2393  
Fig. 14A



SS-2394  
Fig. 14AN



SS-2395  
Fig. 22



SS-2396  
Fig. 27



SS-2397  
Fig. 207



SS-2398  
Fig. 29



SS-2399  
Fig. 206



SS-2400  
Fig. 208



SS-2401  
Fig. 209



SS-2402  
Fig. 1



SS-2403  
Fig. 1A



SS-2404  
Fig. 2



SS-2405  
Fig. 2A



SS-2406  
Fig. W2A



SS-2407  
Fig. 0



SS-2408  
Fig. 00



SS-2409  
Fig. 210



SS-2410  
Fig. 211



SS-2411  
Fig. 212



SS-2412  
Fig. 6



SS-2413  
Fig. 9



SS-2414  
Fig. N06



SS-2415  
Fig. U67



SS-2416  
Fig. 214



SS-2417  
Fig. P1



SS-2418  
Fig. P2



SS-2419  
Fig. G-1



SS-2420  
Fig. G-2

# CROWN REMOVER

- Инструменты для удаления коронок
- Arrache-couronnes
- Teleskopkronenzangen
- Инструменти для видалення коронок
- Arranca-corona
- مزيلات القناج



**SS-2421**  
Crown Spreaders



**SS-2421**  
Universal  
Fig. 0



**SS-2422** **SS-2423**



**SS-2424**

Manual Crown Removers  
Handle with 3 tips **DE-1551**  
Only 3 tips **SS-2422** to **SS-2424**



**SS-2425** **SS-2426**



**SS-2427**

Manual Crown Removers  
Handle with 3 tips **DE-1555**  
Only 3 tips **SS-2425** to **SS-2427**



**SS-2428**  
Manual Crown  
Remover



**SS-2429**  
Manual Crown Remover



**SS-2430**  
Complete with 3 tips  
and tightening keys



semi-automatic crown  
& bridge remover



**SS-2431**



**A**

**B**



**SS-2432**  
Manual Crown Remover



**A**



**B**



**C**



**D**



**E**



## MATRIX RETAINERS

- Матрицедержатели
- Porte Matrices
- Matrizenspanner
- Матрицеутримувачи
- Porta Matrices
- مصفوفة الخدم



SS-2433  
Fig. 5  
Ivory 8  
5 cm



SS-2432  
Fig. 6  
Ivory 8  
6 cm



SS-2433  
Fig. 7  
Ivory 8  
7 cm



SS-2434  
Fig. 1  
Tofflemire-Universal



SS-2435



SS-2436



SS-2437

### Siqveland Retainers



SS-2438  
Fig. 2  
Tofflemire-Junior



SS-2439  
Fig. 3  
Tofflemire-Senior



SS-2440  
Narrow



SS-2441  
Wide

### Amalgam Well



SS-2442  
Stainless Steel  
Amalgam Well



SS-2443  
Ivory 12



SS-2444  
Ivory 1



SS-2445  
Ivory



SS-2446  
Elliot

# AMALGAM INSTRUMENTS

- Инструменты для амальгамы
- Instruments pour amalgame
- AmalgamisInstrumente
- Инструменти для амальгами
- Instrumentos para amalgama
- الصكوك الملعفم



SS-2447  
Fig. 10  
165mm  
English pattern



SS-2448  
Fig. 1  
185mm  
German pattern



SS-2449  
Fig. 1  
150mm  
Swiss pattern



SS-2450  
Fig. 1  
150mm



SS-2451  
Fig. 2  
150mm, 45°



SS-2452  
Fig. 3  
140mm, 90°



SS-2453  
Chip Blower



SS-2454



SS-2455



SS-2456



SS-2457  
Water Syringe



## AMALGAM INSTRUMENTS

- Инструменты для амальгамы
- Instruments pour amalgame
- Amalgamis\strumente
- Инструменты для амальгами
- Instrumentos para amalgama
- الصنوك الملقم

### AMALGAM CARRIERS

#### TIP SIZES FOR DISTAL OR SINGLE-END

1.5 mm



**SS-2459**  
Mini/  
Single-End

2.0 mm



**SS-2460**  
Regular  
Single-End

2.8 mm



**SS-2461**  
Large  
Single-End

1.5 mm



**SS-2462**  
Mini  
Distal

2.0 mm



**SS-2463**  
Regular  
Distal

#### TIP SIZES FOR DOUBLE-END

1.5 mm



2.0 mm  
**SS-2464**  
Mini/  
Regular

2.8 mm



2.0 mm  
**SS-2465**  
Large/  
Regular

3.2 mm



2.0 mm  
**SS-2466**  
Jumbo/  
Regular



**SS-2467**  
Amalgam  
Well

**SS-2458**  
Single-End

#### TIP SIZES FOR DOUBLE-END

**SS-2468** - 1.5mm-2.0mm  
**SS-2469** - 2.0mm-2.8mm  
**SS-2470** - 2.0mm-3.2mm

**SS-2471** - 1.0mm-2mm  
**SS-2472** - 2.0mm-3mm  
**SS-2473** - 2.0mm-4mm

**SS-2474** - 1.5mm-2.0mm  
**SS-2475** - 2.0mm-2.8mm  
**SS-2476** - 2.0mm-3.2mm

**SS-2477** - 1.0mm-2mm  
**SS-2478** - 2.0mm-3mm  
**SS-2479** - 2.0mm-4mm

**SS-2480** - 1.5mm-2.0mm  
**SS-2481** - 2.0mm-2.8mm  
**SS-2482** - 2.0mm-3.2mm

**SS-2483** - 1.0mm-2mm  
**SS-2484** - 2.0mm-3mm  
**SS-2485** - 2.0mm-4mm

**SS-2486** - 1.5mm-2.0mm  
**SS-2487** - 2.0mm-2.8mm  
**SS-2488** - 2.0mm-3.2mm

**SS-2489** - 1.0mm-2mm  
**SS-2490** - 2.0mm-3mm  
**SS-2491** - 2.0mm-4mm

**SS-2491** - 1.5mm  
**SS-2493** - 2.0mm  
**SS-2494** - 2.0mm  
**SS-2495** - 3.0mm

# CHISELES, BONE FILES & SPOONE CURETTE





ROOT PLANNING FILES



SS-2508  
Kramer-Nevins  
Bone Chisel



SS-2509  
Kramer-Nevins  
Bone Chisel



SS-2510  
Molt 18.5cm  
Auto Clavable  
Plastic Tips.

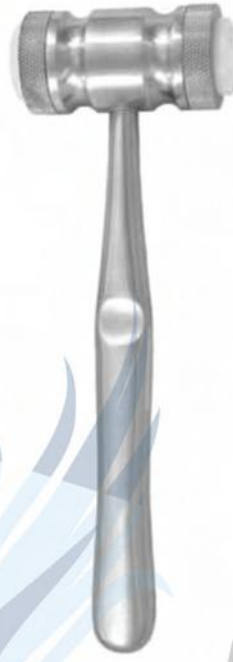

SS-2511  
Mead 18.5cm  
Non Auto Clavable  
Plastic Tips.



SS-2512  
Miller



SS-2513  
Miller

BONE FILES



SS-2514  
Miller 21



SS-2515  
Miller 1X  
cross cut



SS-2516  
Miller 2X  
cross cut



SS-2517  
Miller 52



SS-2518  
Wahl 1

# PERIODONTAL INSTRUMENTS

- Инструменты пародонтологические
- Instruments pour la parodontologie
- Instrumente für die Parodontologie
- Інструменти пародонтологічні
- Instrumentos para periodoncía
- الصكوك اللثة

## PERIOSTEEL ELEVATORS



**SS-2519**  
Ohl 10

**SS-2520**  
Howard 9H

**SS-2521**  
Freer

**SS-2522**  
Freer 15

**SS-2523**  
Freer 16

**SS-2524**  
10.0mm

**SS-2525**  
6.4mm  
Raspator, Raspatory  
Length 175 mm

**SS-2526**  
3.0mm

**SS-2527**  
4.0mm

**SS-2528**  
5.0mm

**DE-1662**  
7.0mm

**Partsche 140 mm**  
SS-2530 3mm  
SS-2531 4mm  
SS-2532 5mm  
SS-2533 6mm

**Partsche 170 mm**  
SS-2534 3mm  
SS-2535 4mm  
SS-2536 5mm  
SS-2537 6mm

**Partsche 140 mm**  
SS-2538 3mm  
SS-2539 4mm  
SS-2540 5mm  
SS-2541 6mm

**Partsche 170 mm**  
SS-2542 3mm  
SS-2543 4mm  
SS-2544 5mm  
SS-2545 6mm

**Raspator, Williger**  
Length 170 mm, different widths  
(4 mm, 5 mm or 7 mm)



## PERIODONTAL INSTRUMENTS

- Инструменты пародонтологические
- Instruments pour la parodontologie
- Instrumente für die Parodontologie
- Инструменти пародонтологічні
- Instrumentos para periodoncia
- الصكوك اللثة

To separate tissue tooth or bone. tp hold tissue away from surgical site.

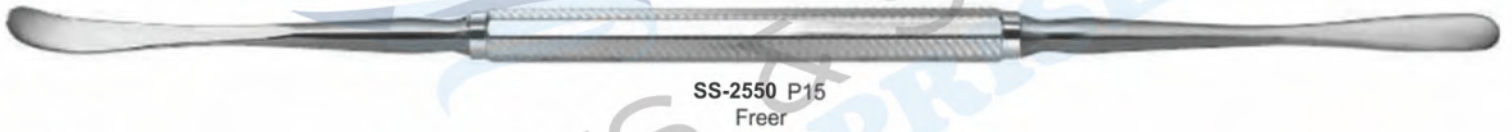
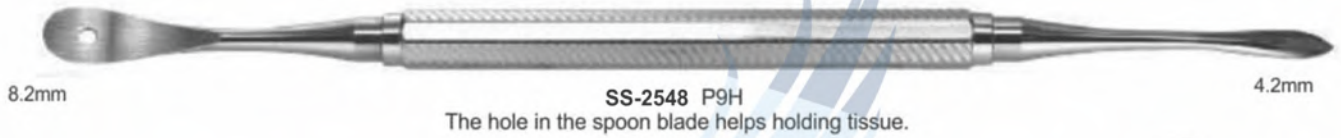

# PERIODONTAL INSTRUMENTS

- Инструменты пародонтологические
- Instruments pour la parodontologie
- Instrumente für die Parodontologie
- Інструменти пародонтологічні
- Instrumentos para periodoncia
- الصكوك اللثة



SS-2556



SS-2557  
P24G



SS-2558  
titanium Periosteal Elevator for Implan5



SS-2559  
S1



SS-2560  
Hirschfeld



SS-2561  
9S



10mm

SS-2562  
Selden

13mm

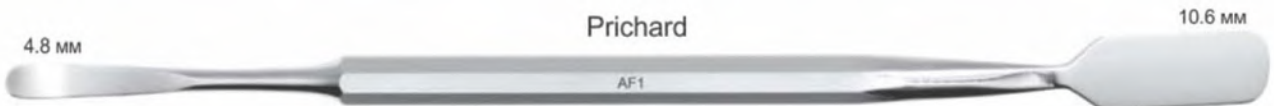

4.8 mm

Prichard

10.6 mm

SS-2563  
Friedmann



SS-2564  
Schmidlin

6.9 mm



## SCALPEL HANDLES

- Ручки для скальпелей
- Manches de bistouris
- Skalpellgriffe
- Ручки для скальпелів
- Mangos de bisturi
- مشرط مقابض



SS-2565  
Fig.3  
12.7cm



SS-2566  
Fig.3G  
12.7cm



SS-2567  
Fig.4  
13.7cm



SS-2568  
Double Handle  
No.4 + No.3  
16.3cm



SS-2569  
Fig. 7  
16.5cm



SS-2570  
Scalpel Handle Straight  
for blades #10-15  
14.5cm



SS-2571  
Micro Surgical Scalpel  
Handle titanium  
13.5cm



SS-2572  
Fig. 5  
14.5cm



SS-2573  
Fig. 5A  
14.5cm



Locks At 90°, 60°, 30°,  
Straight, 120°, 150°, 180°  
Angles



SS-2574  
6 Way Adjustable Angled  
Scalpel Handle

# MALLETS - PLASTER SHEARS - SAWS & BLADES



**SS-2575**  
Metal tip  
220 mm  
Hammer With Wooden Handle



**SS-2576**  
Metal tip  
220 mm

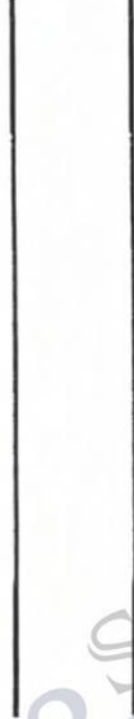

**SS-2577** 1  
For plaster

**SS-2578** 2  
For metal



**SS-2579**  
Fret saw  
250 mm



**SS-2580**  
Small  
Saw Blades



**SS-2581**  
Large  
Saw Blades



**SS-2582**  
Ceri Saw



Special Inox  
**SS-2583** 170mm  
**SS-2584** 200mm



**SS-2585**  
Plaster Shears  
200 mm



Crucible Tongs  
**SS-2586** 250 mm  
**SS-2587** 320 mm



**SS-2588**  
Ceri Saw  
180 mm



**SS-2589**  
Blade  
0,12x5 mm  
Conf. 12 pcs



**SS-2590**  
Blade  
0,25x5 mm  
Conf. 12 pcs



**SS-2591**  
Blade  
0,25x3 mm  
Conf. 12 pcs





Behind Every Smile is a Story

- QUALITY - ЯКІСТЬ • PRECISION - ТОЧНІСТЬ • ACCURACY - ПРАВИЛЬНІСТЬ • DURABILITY - ЗНОСОСТІЙКІСТЬ

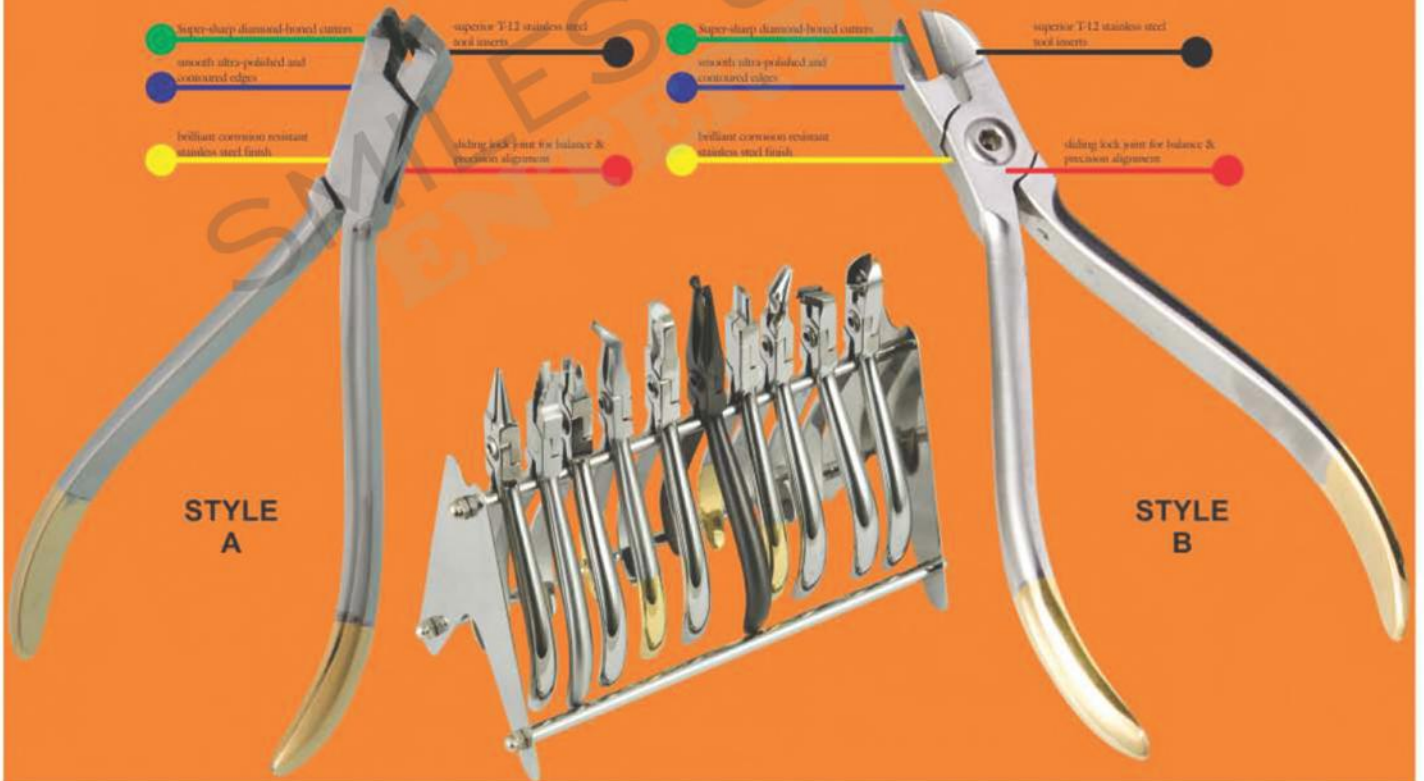

# ORTHODONTIC INSTRUMENTS

- Инструменты ортодонтические
- Instrumentos Ortodonticos
- Orthodontische Instrumente
- Инструменти ортодонтични
- Instruments Orthodontiques
- أدوات تقويم الأسنان



**SS-2592**  
Height Gauge 0.18  
Aluminum



**SS-2593**  
Height Gauge 0.22  
Aluminum



**SS-2594**  
Height Gauge 0.18  
Stainless Steel



**SS-2595**  
Height Gauge 0.22  
Stainless Steel



**SS-2596**  
Moveable  
Height Gauge



**SS-2597**  
Endo Finger  
Ruler Span  
Measure Scale



**SS-2598**  
Endo Finger  
Ruler Span  
Measure Scale



**SS-2599**  
Endo Finger  
Ruler Span  
Measure Scale



**SS-2601**  
Positive  
Postioner



**SS-2602**  
Strip Saw



**SS-2603**  
Bone Bracket Gauge



**SS-2600**  
Endo Finger Ruler  
Span Measure Scale



**SS-2604**  
Endo Finger Ruler  
Span Measure Scale



## ORTHODONTIC INSTRUMENTS

- Инструменты ортодонтические
- Instrumentos Ortodonticos
- Orthodontische Instrumente
- Инструменти ортодонтични
- Instruments Orthodontiques
- أدوات تقويم الأسنان



**SS-2605**  
Measuring Loop  
angled, length  
175 mm,  
measuring range  
0 - 40 mm



**SS-2606**  
Measuring Loop  
straight length  
175 mm,  
measuring range  
0 - 40 mm



**SS-2607**  
Measuring loop, Castroviejo  
angled, length 175 mm,  
measuring range 0 - 40 mm,  
with window



**SS-2608**  
Measuring Loop  
straight length 90 mm,  
measuring range  
0 - 40 mm.

**SS-2609**  
Castroviejo Calipers,  
20mm  
90mm



**SS-2610**  
Measuring Loop  
angled, length 90 mm,  
measuring range  
0 - 40 mm.

**SS-2611**  
Castroviejo Calipers  
20mm, 45°  
90mm



**SS-2612**  
Castroviejo Calipers  
20mm  
90mm



**SS-2613**  
Fig. 1  
Iwanson  
spring caliper  
For metal and  
porcelain.



**SS-2614**  
Fig. 2  
Iwanson  
spring caliper  
For wax.

# ORTHODONTIC INSTRUMENTS

- Инструменты ортодонтические
- Instrumentos Ortodonticos
- Orthodontische Instrumente
- Инструменти ортодонтични
- Instruments Orthodontiques
- ادوات تقويم الأسنان



SS-2615  
Boley Gauge



SS-2616  
Vernier Gauge



SS-2617  
Alluminium Caliper  
up to 200mm



SS-2618  
Boley Gauge



SS-2619  
Delux Boley  
Gauge

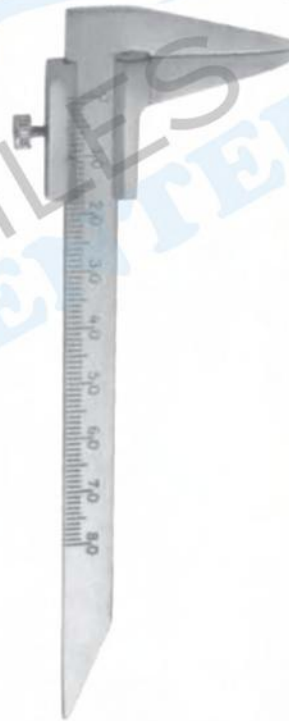

SS-2620  
Beerendonk  
130mm  
Mini Gauge



SS-2621  
Compasso  
De Willis



SS-2622  
Dentaurum  
Ruler



SS-2623  
Ruler Wedge



SS-2624  
Ruler



## ORTHODONTIC INSTRUMENTS

- Инструменты ортодонтические
- Instrumentos Ortodonticos
- Orthodontische Instrumente
- Инструменти ортодонтични
- Instruments Orthodontiques
- أدوات تقويم الأسنان

### Bracket Holder Tweezers



**SS-2625**  
Deluxe Bracket  
Holder Tweezers



**SS-2626**  
Deluxe Bracket  
Holder Tweezers



**SS-2627**  
Direct Bond Bracket  
Holder Tweezers



**SS-2628**  
Bracket Tweezers  
Slot Aligner



**SS-2629**  
Direct Bond  
Bracket Holder  
Tweezers, Small Tip



**SS-2630**  
Exact Bracket  
Holder Tweezers



**SS-2631**  
Bracket Placing  
Tweezers



**SS-2632**  
Easy Access  
Tweezers



**SS-2633**  
Bracket Placer  
Tweezers  
(Extra Fine Tip)



**SS-2634**  
Deluxe Bracket  
Holder Tweezers  
135mm



**SS-2635**  
Easy Eccess  
Tweezers



**SS-2636**  
Slipper  
Tweezers



**SS-2637**  
Direct Bonding  
Bracket Holders  
135mm



**SS-2638**  
Direct Bonding  
Bracket Holders  
136mm



**SS-2639**  
Direct Bonding  
Bracket Holders  
135mm



**SS-2640**  
Deluxe Bracket  
Holder



**SS-2641**  
Direct Bonding  
Bracket Holders  
140mm

# ORTHODONTIC INSTRUMENTS

- Инструменты ортодонтические
  - Instrumentos Ortodonticos
  - Orthodontische Instrumente
- Инструменти ортодонтични
  - Instruments Orthodontiques
  - ادوات تقويم الأسنان



**SS-2642**  
Band seater  
auto cleavable



**SS-2643**  
Band seater  
auto cleavable  
Triangle Shape



**SS-2644**  
Band seater  
auto cleavable  
Square Shape



**SS-2645**  
Band seater  
auto cleavable  
Round Shape



**SS-2646**  
Mershon Band  
Pusher  
140mm



**SS-2647**  
Band seating &  
removing  
instruments



**SS-2648**  
Ortho Light double  
ended  
ligature director  
scaler



**SS-2649**  
Ortho Light Band  
Pusher Scaler



**SS-2650**  
Band Seating &  
Removing  
Silicon Grip



**SS-2651**  
Ligature Instrument  
Silicon Grip



**SS-2652**  
Elastic Instrument  
Silicon Grip



**SS-2653**  
Distal Bender  
Silicon Grip



**SS-2654**  
Distal Bender  
Silicon Grip



**SS-2655**  
Distal Bender  
Silicon Grip



## ORTHODONTIC INSTRUMENTS

- Инструменты ортодонтические
- Instrumentos Ortodonticos
- Orthodontische Instrumente
- Инструменти ортодонтични
- Instruments Orthodontiques
- أدوات تقويم الأسنان



**SS-2656**  
Ortho light scaler double ended



**SS-2657**  
Ortho light scaler double ended



**SS-2658**  
Ortho light scaler double ended



**SS-2659**  
Twiel-on elastic module instrument



**SS-2660**  
Twiel-on elastic module instrument



**SS-2661**  
Schure Band Seater



**SS-2662**  
Ortho light scaler



**SS-2663**  
Ortho light scaler



**SS-2664**  
Ortho light scaler heavy



**SS-2665**  
Ortho instrument



**SS-2666**  
Ortho instrument

# ORTHODONTIC INSTRUMENTS

- Инструменты ортодонтические
- Instrumentos Ortodonticos
- Orthodontische Instrumente
- Инструменти ортодонтични
- Instruments Orthodontiques
- ادوات تقويم الأسنان



**SS-2667**  
Ortho Light double ended  
ligature director



**SS-2668**  
Ortho Light double ended ligature scaler director tivate coil spring  
are remove modules with one instruments



**SS-2669**  
Ortho band pusher scaler



**SS-2670**  
Ortho ligature director single ended



**SS-2670**  
Ortho Light double ended ligature  
director scaler



**SS-2671**  
Ortho Light double ended ligature scaler/director  
tivate coil spring are remove modules with one instruments



**SS-2672**  
Ortho Light double ended ligature director



**SS-2673**  
Ortholite Ligature Director Scaler



**SS-2674**  
Ortho light ligature director double ended



**SS-2675**  
Double ended cement spatula



**SS-2676**  
Ortho light scaler single ended



## PLIERS FOR ORTHODONTICS & PROSTHETICS

- Щипцы для ортодонтии и протезирования
- Pincers pour l'orthodontie et la prothèse
- Zangen für Kieferorthopädie und Prothetik
- Щипці для ортодонції та протезування
- Alicates para ortodoncia y prótesis
- كمشة لتقويم الأسنان بروستھتیس

### BOX JOINT PLIERS

**SS-2677**  
Universal Dolphin Style  
Wire Bending & cutting pliers



**SS-2683**  
Bracket Removing Plier curved  
Bracket Removing Plier curved for  
easy removal of brackets in the  
posterior region. Length 130mm



**SS-2678 Band Removing Plier**  
The curved blade of the band  
removing plier can strip easily  
and gently remove directly to  
the tooth. Length 130mm



**SS-2684**  
Young Wire Bending &  
Loop Forming Pliers



**SS-2679**  
Tweed Loop  
forming Pliers



**SS-2685**  
Wire Bending &  
Loop Forming Pliers



**SS-2680**  
How Plier curved  
Universally usable tool for  
the multiband technology for  
wires up to .028".  
Length 130mm



**SS-2686**  
Adams, small wire bending  
and loop forming Pliers



**SS-2681 How Plier**  
Universally usable tool for the  
multiband technology for wires  
up to .028".  
Length 135mm



**SS-2687**  
Bracket Removing Plier Round Box  
Bracket removing plier for comfortable  
and quick removal of the brackets.  
Length 135mm



**SS-2682**  
Nance Loop  
forming Pliers



**SS-2688**  
Weingart Plier medium  
Weingart plier that are ideal due to  
their curved tip for setting sheets and  
is capable of bending the ends.  
Length 145mm



# PLIERS FOR ORTHODONTICS & PROSTHETICS

- Щипцы для ортодонтии и протезирования
- Pincers pour l'orthodontie et la prothèse
- Zangen für Kieferorthopädie und Prothetik
- Щипці для ортодонції та протезування
- Alicates para ortodoncia y prótesis
- كمشة لتقويم الأسنان بروتستیس

## BOX JOINT PLIERS

**SS-2689 Adams Plier Round Box**  
Adams pliers for bending wire arches and bends right angles for wires up to .022", .025 tip to beak. Length 125mm



**SS-2695 Adams Plier**  
Adams pliers for bending wire arches and bends right angles for wires up to .022", .025 tip to beak. Length 125mm



**SS-2690 Falcon Beak Contouring Pliers.**



**SS-2696 Tweed Loop Formin Pliers**



**SS-2691**  
wires up to 0.020" / 0.7mm.



**SS-2697 Bird Beak Plier Standard**  
Bird Beak Wire bending plier without notches, which is suitable as a universal utility tool. Length 125mm



**SS-2692 Johnson Contouring Pliers**



**SS-2698 Mini Ligature cutters**



**SS-2693 Aderer**  
Large wire bending and loop forming pliers



**SS-2699 Small Fluch-cut distal and cutting Pliers**  
with safety hold fitted with un-breakable, corrosion resistant and durable stainless steel tips



**SS-2694 Tweed / angle rectangular arch forming & Torquing pliers**



**SS-2700 Large Fluch-cut distal and cutting Pliers**  
with safety hold fitted with un-breakable, corrosion resistant and durable stainless steel tips





## PLIERS FOR ORTHODONTICS & PROSTHETICS

- Щипцы для ортодонтии и протезирования
- Pincettes pour l'orthodontie et la prothèse
- Zangen für Kieferorthopädie und Prothetik
- Щипці для ортодонції та протезування
- Alicates para ortodoncia y prótesis
- كمشة لتقويم الأسنان بروستیتس

### BOX JOINT PLIERS

SS-2701

**Tweed / Angel**

1.78mm (.070") wide tips arch forming and torquing pliers



SS-2707

**Contouring Plier**



SS-2702

**Tweed / Angel**

1.78mm (.070") wide tips arch forming and torquing pliers



SS-2708

**Bands & Crowns Plier**  
in order to skirt



SS-2703

**Lingual / Palatal arch**  
forming pliers



SS-2709

**Ligature Forming Pliers**



SS-2704

**Aderer**

Facebow loop forming Pliers



SS-2710

for double back and triple back bands in 0.30" / 0.76mm & 0.36" / 0.91mm lingual arch wires



SS-2705

**Waldsavhs wire bending and cutting pliers**



SS-2711

**Bird Beak Wire Bending & cutting pliers**



SS-2706 Aderer Plier

For the manufacturing of appliances and activation of wires for wires up to .030" .fine tip and up to .036" mean tip.  
Length 130mm



SS-2712

**Weingart Plier medium**

Weingart plier that are ideal due to their curved tip for setting sheets and is capable of bending the ends.  
Length 145mm

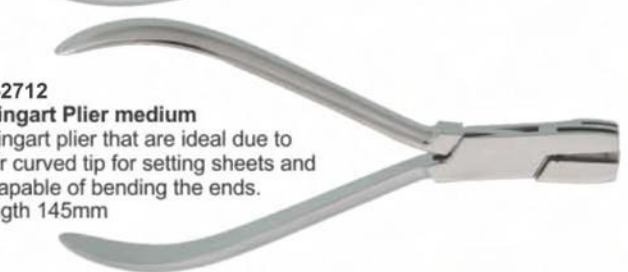

# PLIERS FOR ORTHODONTICS & PROSTHETICS

- Щипцы для ортодонтии и протезирования
- Pincas pour l'orthodontie et la prothèse
- Zangen für Kieferorthopädie und Prothetik
- Щипці для ортодонції та протезування
- Alicates para ortodoncia y prótesis
- كمشة لتقويم الأسنان بروستیتیس

## L-KEY JOINT PLIERS



**SS-2713**  
Distal end cutter with safety hold, mini head, long handles.  
fitted with un-breakable, corrosion resistant and durable stainless steel tips

- 0.30 mm to 0.50 mm (.012" to .020")
- Max. 0.46 mm x 0.64 mm (.018" x .025")
- ⊗ 0.38 mm to 0.53 mm (.0155" to .0215")
- ⊗ Max. 0.53 mm x 0.64 mm (.021" x .025")



**SS-2714**  
Flush-cut distal end cutter with safety hold fitted with un-breakable, corrosion resistant and durable stainless steel tips

- 0.30 mm to 0.50 mm (.012" to .020")
- Max. 0.46 mm x 0.64 mm (.018" to .025")



**SS-2715**  
Soft wire and ligature cutter, Mini fitted with un-breakable, corrosion resistant and durable stainless steel tips

- ☞ .25 mm to .38 mm (.010" to .015")



**SS-2716**  
Soft wire and ligature cutter, standard fitted with un-breakable, corrosion resistant and durable stainless steel tips

- ☞ .25 mm to .38 mm (.010" to .015")



**SS-2717**  
Soft wire and ligature cutter, 15° angled fitted with un-breakable, corrosion resistant and durable stainless steel tips

- ☞ .25 mm to .38 mm (.010" to .015")



**SS-2718**  
Soft wire and ligature cutter, 45° angled fitted with un-breakable, corrosion resistant and durable stainless steel tips

- ☞ .25 mm to .38 mm (.010" to .015")



**SS-2719**  
Hard wire cutter, straight Fitted with un-breakable, corrosion resistant and durable stainless steel tips

- 0.30 mm to 0.50 mm (.012" to .020")
- Max. 0.56 mm x 0.71 mm (.022" x .028")



**SS-2720**  
Hard wire cutter, 15° angled Fitted with un-breakable, corrosion resistant and durable stainless steel tips

- 0.30 mm to 0.50 mm (.012" to .020")
- Max. 0.56 mm x 0.71 mm (.022" x .028")



**SS-2721**  
Hard wire cutter, 15° angled Non-autocalavable















- 0.30 mm to 0.50 mm (.012" to .020")
- Max. 0.56 mm x 0.71 mm (.022" x .028")



## PLIERS FOR ORTHODONTICS & PROSTHETICS

- Щипцы для ортодонтии и протезирования
- Pincers pour l'orthodontie et la prothèse
- Zangen für Kieferorthopädie und Prothetik
- Щипці для ортодонції та протезування
- Alicates para ortodoncia y prótesis
- كمشة لتقويم الأسنان بروستیتس

### L-KEY JOINT PLIERS

	 <p><b>SS-2722</b> Band removing pliers</p>		 <p><b>SS-2727</b> Weingart-mini Utility Pliers</p> <ul style="list-style-type: none"> <li>● 0.30 mm to 0.50 mm (.012" to .020")</li> <li>■ Max 0.56 mm x 0.71 mm (.022" x .028")</li> </ul>
	 <p><b>SS-2723</b> Bracket removing pliers angled</p>		<p><b>SS-2728</b> Weingart Utility Pliers</p> <ul style="list-style-type: none"> <li>● 0.30 mm to 0.50 mm (.012" to .020")</li> <li>■ Max 0.56 mm x 0.71 mm (.022" x .028")</li> </ul>
	 <p><b>SS-2724</b> Bracket removing pliers straight</p>		 <p><b>SS-2729</b> How Straight Utility Pliers</p> <ul style="list-style-type: none"> <li>● 0.30 mm to 0.50 mm (.012" to .020")</li> <li>■ Max 0.56 mm x 0.71 mm (.022" x .028")</li> </ul>
	 <p><b>SS-2725</b> Bracket removing pliers with plastic tip</p>		<p><b>SS-2730</b> Angled Utility Pliers</p> <ul style="list-style-type: none"> <li>● 0.30 mm to 0.50 mm (.012" to .020")</li> <li>■ Max 0.56 mm x 0.71 mm (.022" x .028")</li> </ul>
	 <p><b>SS-2726</b> Adhesive removing pliers</p>		 <p><b>SS-2731</b> Wire bending and loop forming pliers Angled (Bird beak)</p> <ul style="list-style-type: none"> <li>● 0.30 mm to 0.50 mm (.012" to .020")</li> <li>■ Max 0.56 mm x 0.71 mm (.022" x .028")</li> </ul>

# PLIERS FOR ORTHODONTICS & PROSTHETICS

- Щипцы для ортодонтии и протезирования
- Pincas pour l'orthodontie et la prothèse
- Zangen für Kieferorthopädie und Prothetik
- Щипці для ортодонції та протезування
- Alicates para ortodoncia y prótesis
- كمامة لتقويم الأسنان بروسثیتیس

## L-KEY JOINT PLIERS



**SS-2732**  
Multi-purpose pliers, bird beak,  
De la rosa and cutter in one

- 0.30 mm to 0.50 mm (.012" to .020")
- Max. 0.46 mm x 0.56 mm (.018" x .022")



**SS-2737**  
Stop pliers V-Bebd - 1mm

- 0.30 mm to 0.50 mm (.012" to .020")
- Max. 0.43 mm x 0.56 mm (.017" x .028")



**SS-2733**  
Cinch Back / tie back  
Distal end bending pliers

- 0.30 mm to 0.50 mm (.012" to .020")
- Max. 0.56 mm x 0.71 mm (.022" x .028")



**SS-2738**  
Lingual / palatal arch forming plies

- 0.76 mm (.030") / 0.91 mm (.036")



**SS-2734**  
Hammer head  
Distal end bending pliers

- 0.30 mm to 0.50 mm (.012" to .020")
- Max. 0.56 mm x 0.71 mm (.022" x .028")



**SS-2739**  
Torquing pliers set



**SS-2735**  
Nance  
Loop forming pliers

- 0.36 mm to 0.71 mm (.014" to .028")
- Max. 0.56 mm x 0.71 mm (.022" x .028")



**SS-2740**  
Tweed / angel  
Rectangular arch forming and  
torquing pliers

- 0.30 mm to 0.71 mm (.012" to .028")
- Max. 0.56 mm x 0.71 mm (.022" x .028")



**SS-2736**  
Detailing step pliers / Bayonet  
bending pliers - 1mm

- 0.30 mm to 0.50 mm (.012" to .020")
- Max. 0.56 mm x 0.71 mm (.022" x .028")



**SS-2741**  
Surgical ball hook crimping pliers,  
angled



**SS-2742**  
Surgical ball hook crimping  
pliers, straight





## PLIERS FOR ORTHODONTICS & PROSTHETICS

- Щипцы для ортодонтии и протезирования
- Pincers pour l'orthodontie et la prothèse
- Zangen für Kieferorthopädie und Prothetik
- Щипці для ортодонції та протезування
- Alicates para ortodoncia y prótesis
- كمشة لتقويم الأسنان بروستھتیس

### L-KEY JOINT PLIERS



**SS-2743**  
Aderer Clamp three jaw wire bending plier for contouring and bending wire up to .30"/.76mm.



**SS-2749**  
Falcon beak contouring plier.

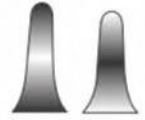

**SS-2744**  
Bird beak plier for bending round, square and rectangle wire up to .30"/.76mm.

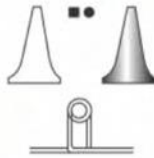

**SS-2750**  
For placement and removal of arch wires, pins and other auxiliaries.



**SS-2745**  
Bird beak plier for light wire bending round, square and rectangular up to .016"/0.41mm.

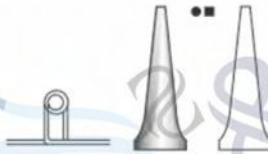

**SS-2751**  
For placement and removal of arch wires, pins and other auxiliaries in angle design



**SS-2746**  
Double Rounded jaw bending pliers, hooks and wire up to .020"/0.51mm.

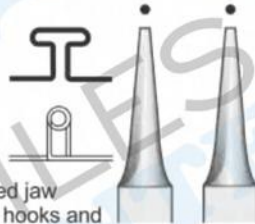

**SS-2752**  
contouring Plier.



**SS-2753**  
Bending plier. In order to skirt molares bands. With grooved. Recommended wire. 016", 018" and 022" 0.41mm, 0.46mm and 0.56mm



**SS-2747**  
Adams pliers for hooks and bending wire up to .030"/0.76mm.



**SS-2754**  
Loop forming in four length 3,4,5 & 6 mm wire capacity 0.22", 56mm.

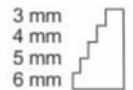

**SS-2748**  
Johnson pliers for crown band contouring



**SS-2755**  
Arch bending plier design for convenient handling of square or rectangular wire, .020" / 0.51mm.



# PLIERS FOR ORTHODONTICS & PROSTHETICS

- Щипцы для ортодонтии и протезирования
- Pincas pour l'orthodontie et la prothèse
- Zangen für Kieferorthopädie und Prothetik
- Щипці для ортодонції та протезування
- Alicates para ortodoncia y prótesis
- كمامة لتقويم الأسنان بروستيتيس

## LAP & L-KEY JOINT PLIERS



**SS-2756**  
In order to skirt bands and crowns.



**SS-2757**  
Wires up to .020" / 0.7mm.

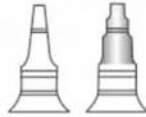

**SS-2758**  
Round and concave plier for loop forming and banding wire up to .20" / .051mm.



**SS-2759**  
Bending for round square or rectangular wire up to 0.30"/0.76mm



**SS-2760**  
for double back and triple back bands in 0.30" / .76mm & 0.36" / .91mm lingual arch wires.



**SS-2761**  
Detailing step plier double-sided offset beak permits bayonet bends. Creates right hand or left hand step-up or stepdown at 1/2, 3/4, or 1mm increments.



**SS-2762**  
"V" bend stop special design makes 1mm "v" bends to shorten archwires or provide a positive stop. Excellent for placing stops in titanium wires. For round or rectangular wires up to .025"



**SS-2763**  
Angle how plier efficient utility plier with serrated beaks for a firm grip. 45 angled tips to access hard to reach areas.



**SS-2764**  
Weingardt plier serrated tips hold wires firmly at a convenient working angle. Tapered beaks fit easily between brackets and hard to reach areas. Our most popular utility plier.



**SS-2765**  
Pin & Ligature Cutters TC.



**SS-2766**  
Mini Pin & Ligature Cutter TC.



**SS-2767**  
Standard Ligature Cutter TC.



**SS-2768**  
V Bend Stop Plier TC.



**SS-2769**  
Angled Direct Bond Bracket Remover TC.



**SS-2770**  
Cutter Str.



Distal Cutter  
14cm  
**SS-2771** 2.5 mm  
**SS-2772** 3.0 mm  
**SS-2773** 3.0 mm

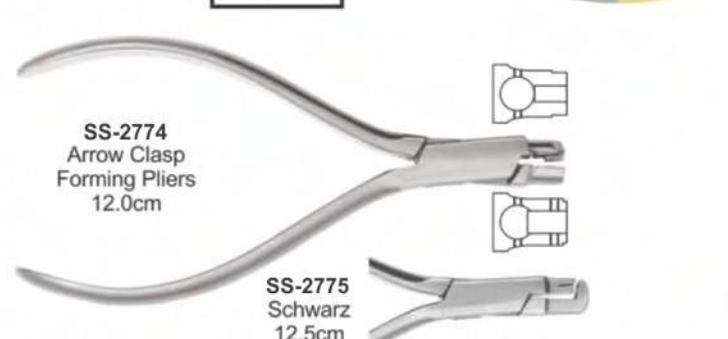

**SS-2774**  
Arrow Clasp Forming Pliers  
12.0cm

**SS-2775**  
Schwarz  
12.5cm





**SS-2776**  
Distal end Cutter, Safety Hold Plier  
(Ideal for Cutting Wire) TC.



**SS-2777**  
Hook Crimping Plier Angled  
Straight TC.



**SS-2778**  
3 Prong Clasp Adjustable  
Plier TC.



**SS-2779**  
Utility Plier Weingart TC.



**SS-2780**  
Direct Bracket Remover  
TC.



**SS-2781**  
Straight Direct Bond Bracket  
Remover TC.



**SS-2782**  
Pin Holding Plier TC.



**SS-2783**  
Hard wire cutters



**SS-2784**  
Elastic Separating Plier  
Round Handle



**SS-2785**  
Elastic  
Separating Plier



**SS-2786 Str.**  
**SS-2787 Cvd.**  
Smaha  
Elastomeric  
ligature  
placing forceps  
140 mm



**SS-2788**  
Elastomeric  
ligature placing  
forceps with  
groove  
Falcon 140 mm



**SS-2789**  
Elastomeric  
ligature placing  
forceps with  
groove  
Falcon 140 mm



# PLIERS FOR ORTHODONTICS & PROSTHETICS

- Щипцы для ортодонтии и протезирования
- Pincas pour l'orthodontie et la prothèse
- Zangen für Kieferorthopädie und Prothetik
- Щипці для ортодонції та протезування
- Alicates para ortodoncia y prótesis
- كمشاة لتقويم الأسنان بروسيثيتيس

## CUTTER, UTILITY PLIERS & WIRE FORMING PLIERS



**SS-2790**  
Weingart Pliers



**SS-2795**  
Adhesive  
Removing Pliers



**SS-2791**  
Slim Weingart  
Pliers



**SS-2796**  
Posterior Band Removing  
Pliers - Long



**SS-2792**  
How Pliers  
Straight



**SS-2797**  
Posterior Band Removing  
Pliers - Short



**SS-2793**  
How Pliers Offset

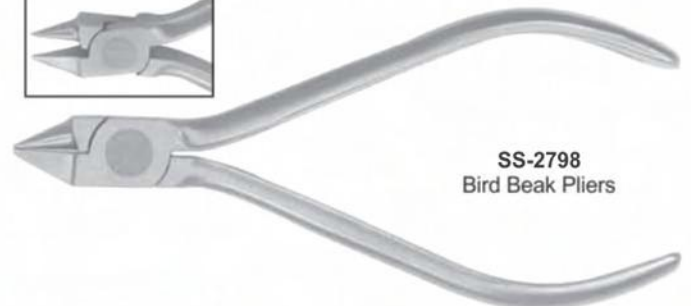

**SS-2798**  
Bird Beak Pliers



**SS-2794**  
Band seating Pliers



Replacement tip and  
hex key included.

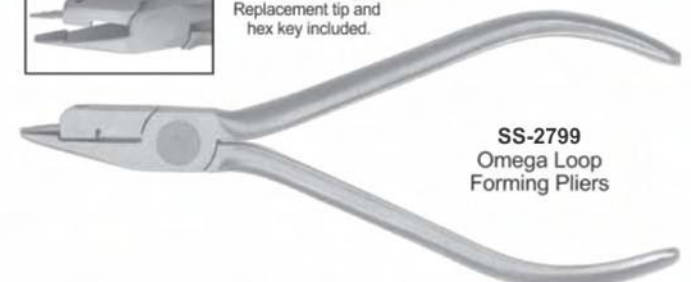

**SS-2799**  
Omega Loop  
Forming Pliers



## PLIERS FOR ORTHODONTICS & PROSTHETICS

- Щипцы для ортодонтии и протезирования
- Pincers pour l'orthodontie et la prothèse
- Zangen für Kieferorthopädie und Prothetik
- Щипці для ортодонції та протезування
- Alicates para ortodoncia y prótesis
- كمشة لتقويم الأسنان بروستیتس

### CUTTERS



**SS-2800**  
Hard  
Wire Cutter 15



**SS-2804**  
Mini Pin &  
Ligature Cutter



**SS-2801**  
Distal End Cutter  
Flush Cut



**SS-2805**  
Hard Wire Cutter  
Straight



**SS-2802**  
Universal Cut & Hold  
Distal End Cutter



**SS-2806**  
Micro-Mini Pin &  
Ligature Cutter



**SS-2803**  
Pin & Ligature  
Cutter



**SS-2807**  
Cutter

## PLIERS FOR ORTHODONTICS & PROSTHETICS

- Щипцы для ортодонтии и протезирования
- Pincas pour l'orthodontie et la prothèse
- Zangen für Kieferorthopädie und Prothetik
- Щипці для ортодонції та протезування
- Alicates para ortodoncia y prótesis
- كمانة لتقويم الأسنان بروستيتيس



**SS-2808**  
Three Jaw Pliers



**SS-2812**  
Jarabak Pliers



**SS-2809**  
Light Wore Bird Beak  
Pliers with Groove



**SS-2813**  
Hollow Chop  
Contouring Pliers



**SS-2810**  
Tweed loop  
Forming Pliers



**SS-2814**  
Lingual Arch  
Forming Pliers



**SS-2811**  
Arch Bending Pliers



**SS-2815**  
Rectangular Arch  
Bending Pliers



## ORTHODONTICS PLIERS STANDS

- Ортодонтия Щипцы Подставки
- Supports de pinces d'orthodontie
- Kieferorthopädie Zangenständer
- Ортодонтия Щипці Підставки
- KFO Zangen Ständer
- تقويم الأسنان كعاشة تقف



**SS-2816**  
Plier Stand  
Stainless Steel.



**SS-2817**  
Plier Stand  
Stainless Steel.



**SS-2818**  
Pliers Stand  
Stainless Rod  
(Aluminum Anodized)  
Stainless Steel



**SS-2819**  
Plier Stand  
Stainless Steel.



**SS-2820**  
Plier Stand  
Stainless Steel.



**SS-2821**  
Plier Stand  
Plastic

# Normal Anatomy – Dental Implants

Bone Level Normal  
(No Bone Loss)

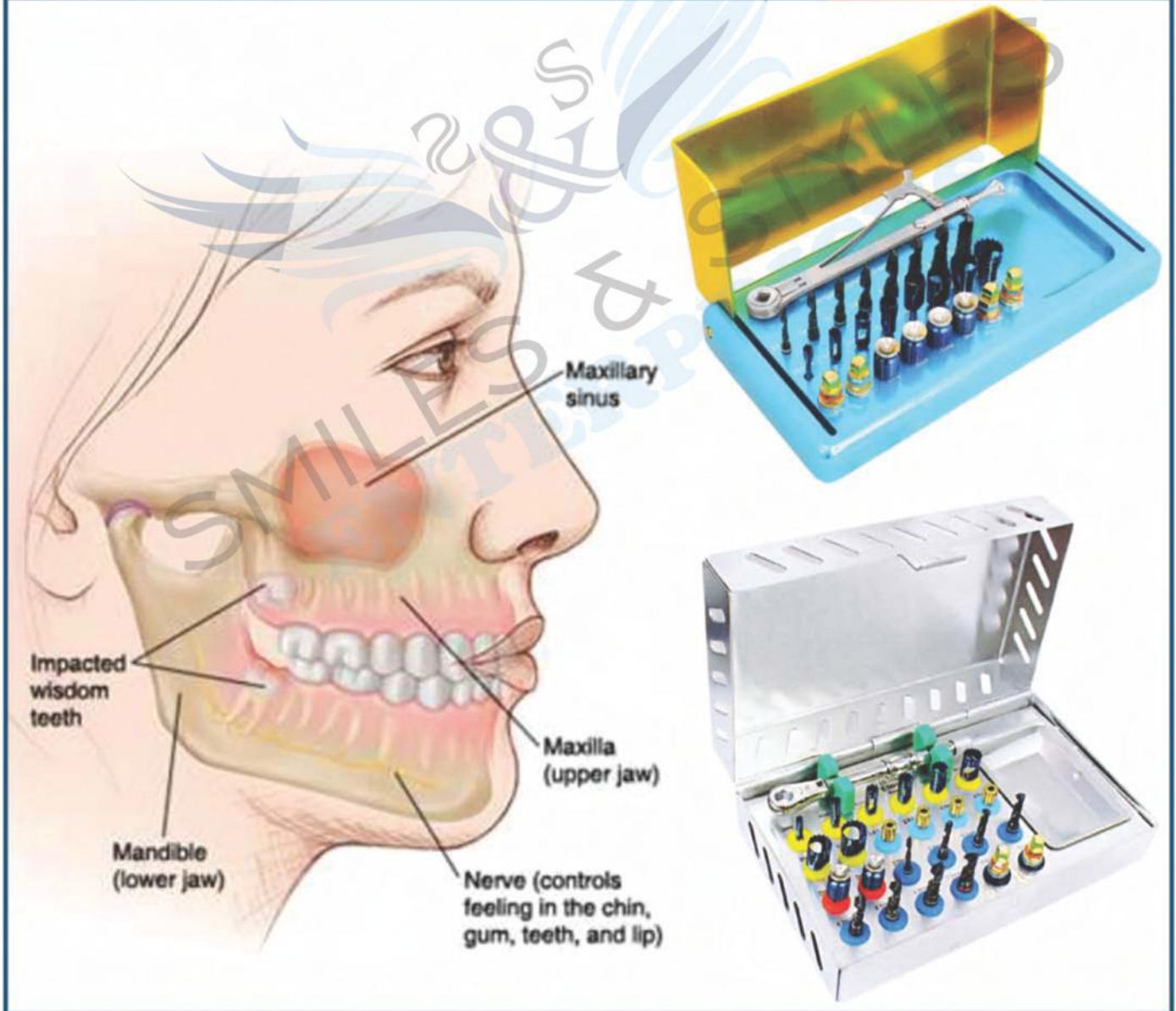
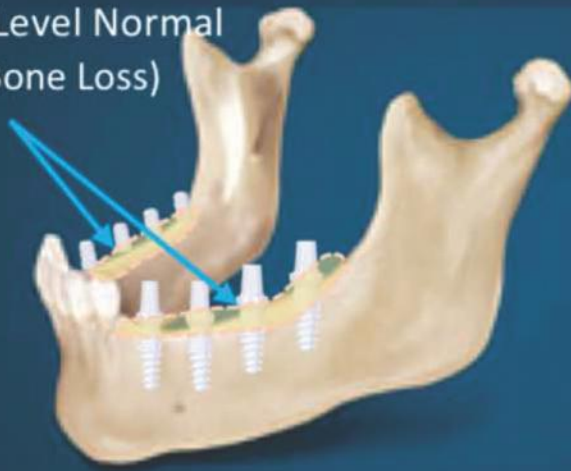



## IMPLANTOLOGY

- Инструменты для имплантологии
- Implantologie
- Implantologie
- Инструменти для імплантології
- Implantologia
- زراعة الأسنان

### IMPLANT GAGES



**SS-2822**  
Multifunctional Meter  
Length 90 mm,  
different sizes,  
8-10-11mm,  
corrosion-resistant

**SS-2823**  
Multifunctional Meter  
Length 90 mm,  
different sizes,  
5-13-15-17 mm,  
corrosion-resistant

**SS-2824**  
Measuring Probe  
Length 170 mm,  
hand shape or flexible  
(6-8-10-14-16 mm),  
corrosion-resistant

**SS-2825**

**SS-2826**

**SS-2827**

**SS-2828**

### IMPLANT GAGES



**SS-2829**

**SS-2830**

**SS-2831**

# IMPLANTOLOGY

- Инструменты для имплантологии
- Implantologie
- Implantologie

- Инструменти для імплантології
- Implantologia
- زراعة الأسنان



**SS-2832**  
Ridge Mapping  
Double Caliper



**SS-2833**  
Bone Thickness Gauge  
40mm, 180mm



**SS-2834**  
Osteometer  
Measuring Forceps For Jaw  
Ridge Width measurement, scale  
on both sides, rustfree, autoclaviv



**SS-2835**  
Micro Boley  
Gauge Twisted



**SS-2836**  
Micro Boley  
Gauge Straight



**SS-2837**  
Ortho Ruler / Cone Socket

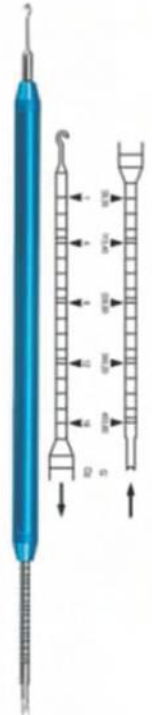

**SS-2838**  
Dynamometer



## IMPLANTOLOGY

- Инструменты для имплантологии
- Implantologie
- Implantologie
- Инструменти для імплантології
- Implantologia
- زراعة الأسنان

### BLACK TITANIUM COLOUR COATED INSTRUMENTS



# IMPLANTOLOGY

- Инструменты для имплантологии
- Implantologie
- Implantologie
- Инструменти для імплантології
- Implantologia
- زراعة الأسنان

## BLACK TITANIUM COLOUR COATED INSTRUMENTS



SS-2847  
A  
Cosmetic  
Contouring

SS-2848  
B  
Cosmetic  
Contouring

SS-2849  
C  
Cosmetic  
Contouring

SS-2850  
D  
Cosmetic  
Contouring

SS-2851  
F  
Cosmetic  
Contouring

SS-2852  
Marginal Ridge  
& Embrasure  
Shaping Instrument

SS-2853  
Occlusal  
Anatomy  
Instrument



## IMPLANTOLOGY

- Инструменты для имплантологии
- Implantologie
- Implantologie
- Инструменти для імплантології
- Implantologia
- زراعة الأسنان

### BLACK TITANIUM COLOUR COATED INSTRUMENTS

#### BURNISHERS

#### FREEDMAN BURNISHERS

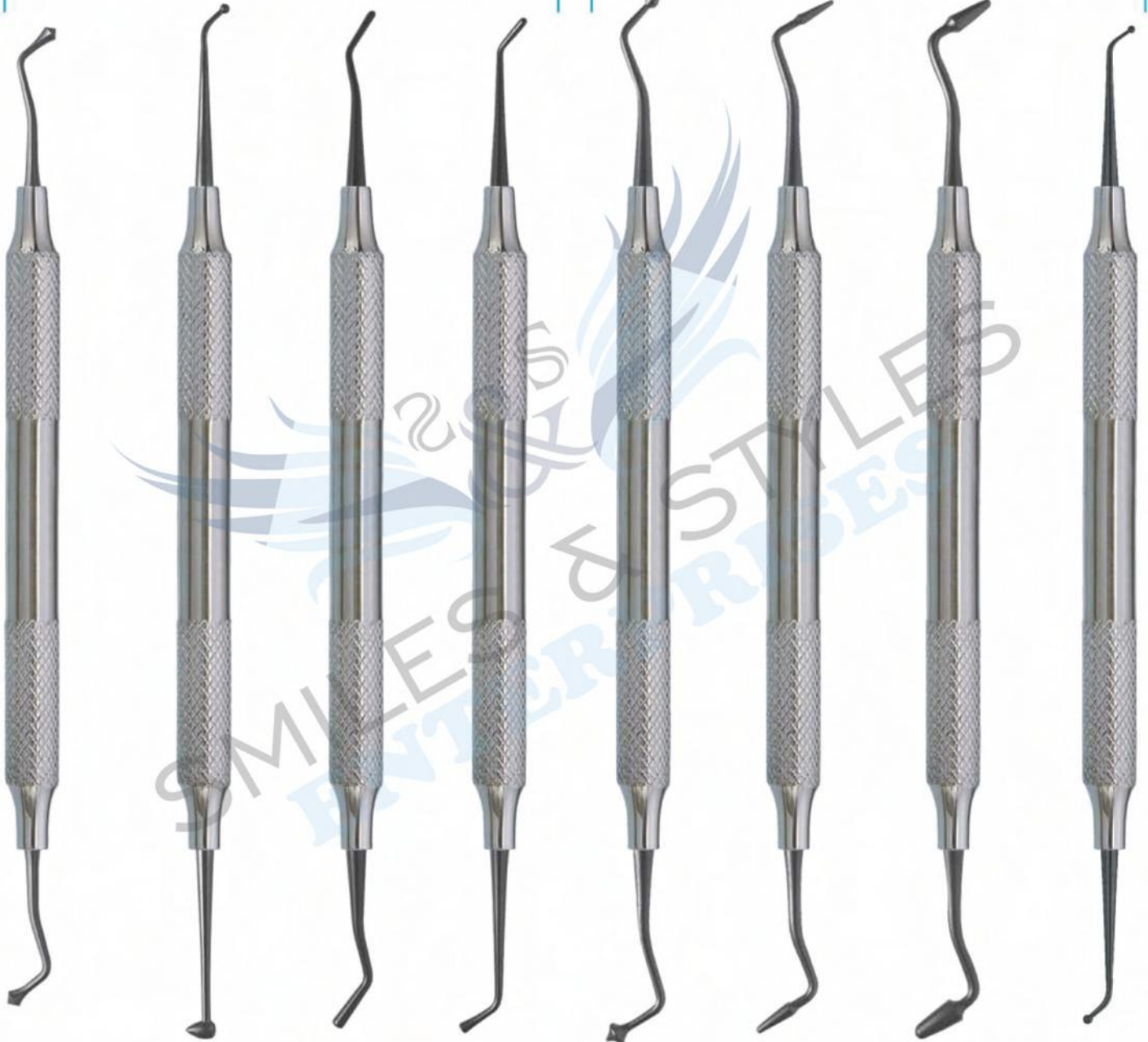

SS-2854  
21B

SS-2855  
27/29

SS-2856  
2  
Ladmore

SS-2857  
3  
Ladmore

SS-2858  
Freedman  
"Duckhead"

SS-2859  
Freedman  
Small Contact  
Forming

SS-2860  
Freedman  
Large Contact  
Forming

SS-2861  
Small/  
Medium Ball  
Burnisher

# IMPLANTOLOGY

- Инструменты для имплантологии
- Implantologie
- Implantologie
- Инструменти для імплантології
- Implantologia
- زراعة الأسنان

## SINUS LIFT INSTRUMENTS HOLLOW HANDLE 9.5MM LENGTH 170MM

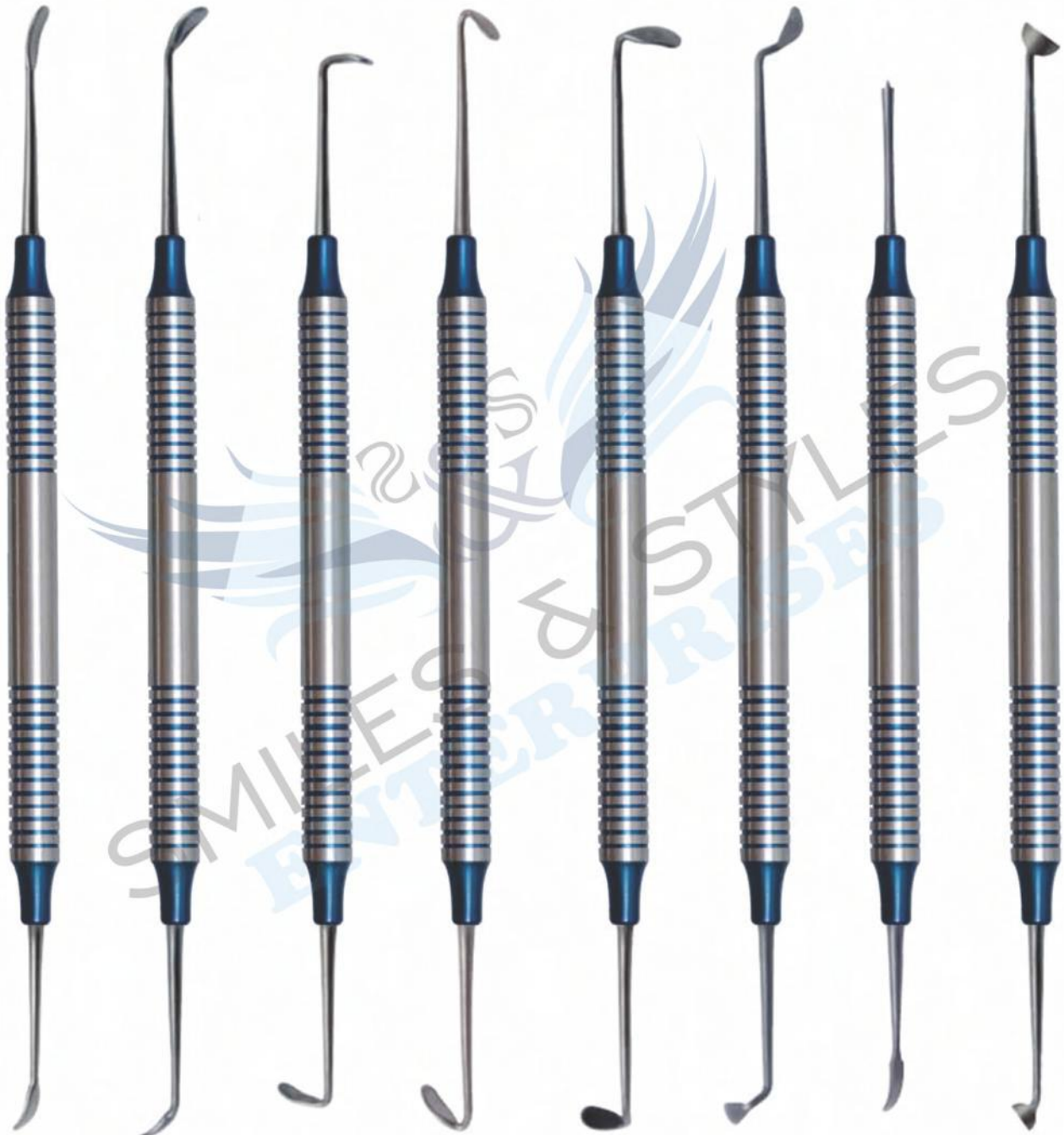

SS-2862  
Sinuslift 1

SS-2863  
Sinuslift 2

SS-2864  
Sinuslift 3

SS-2865  
Sinuslift 4

SS-2866  
Sinuslift 5

SS-2867  
Sinuslift 6

SS-2868  
Membrane  
3Positioning 1

SS-2869  
Condenser 1



## IMPLANTOLOGY

- Инструменты для имплантологии
- Implantologie
- Implantologie
- Инструменти для імплантології
- Implantologia
- زراعة الأسنان

**Sinus Lift Instrument,**  
Flexible Sinus Lift instruments  
reduce the risk of perforation of the  
"Schneider's membrane"



SS-2870  
Fig. 1

SS-2871  
Fig. 2

SS-2872  
Fig. 3

**Sinus Lift Elevator,**  
10 mm Straight grip  
Length 175 mm, Sinus lift elevators, dull,  
for gentle peeling and lifting the  
Schneider membrane



SS-2873  
Fig. 1

SS-2874  
Fig. 2

SS-2875  
Fig. 3

**Sinus lift instrument**  
10 mm Straight grip Length 180 mm,  
Buser (B1, B2, B3) raspatories,  
quality medical stainless steel,  
corrosion-resistant



SS-2876  
B01

SS-2877  
B02

SS-2878  
B03

## IMPLANTOLOGY

- Инструменты для имплантологии
- Implantologie
- Implantologie
- Инструменти для імплантології
- Implantologia
- زراعة الأسنان

Sinus lift instrument 10 mm Straight grip Sinus lift elevators, blunt or sharply curved  
(H01, H02, K03, K04, K78, K77)

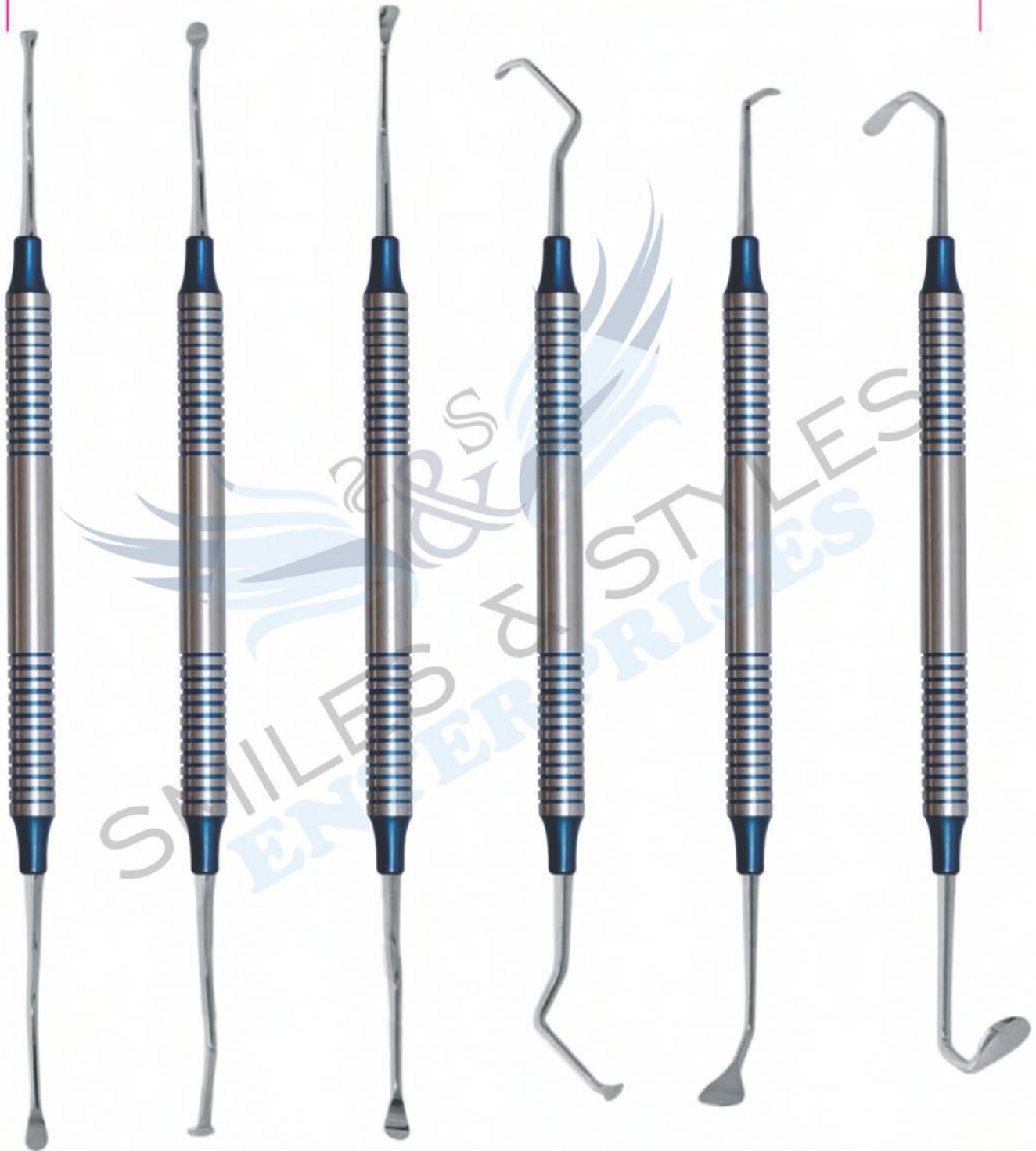

SS-2879  
Sinus lift  
instrument  
H01

SS-2880  
Sinus lift  
instrument  
H02

SS-2881  
Sinus lift  
instrument  
K03

SS-2882  
Sinus lift  
instrument  
K04

SS-2883  
Sinus lift  
instrument  
K78

SS-2884  
Sinus lift  
instrument  
K77



## IMPLANTOLOGY

- Инструменты для имплантологии
- Implantologie
- Implantologie
- Инструменти для імплантології
- Implantologia
- زراعة الأسنان

### Composite Filling Instruments Set of 6 Pcs



SS-2885



SS-2886



SS-2887



SS-2888



SS-2889



SS-2890

#### COMPOSITE INSTRUMENTS USE:

A composite (tooth colored) filling is used to repair a tooth that is affected by decay, cracks, fractures, etc. The decayed or affected portion of the tooth will be removed and then filled with a composite filling.

There are many types of filling materials available, each with their own advantages and disadvantages. You and your dentist can discuss the best options for restoring your teeth. Composite fillings, along with silver amalgam fillings, are the most widely used today. Because composite fillings are tooth colored, they can be closely matched to the color of existing teeth, and are more aesthetically suited for use in front teeth or the more visible areas of the teeth.

As with most dental restorations, composite fillings are not permanent and may someday have to be replaced. They are very durable, and will last many years, giving you a long lasting, beautiful smile.

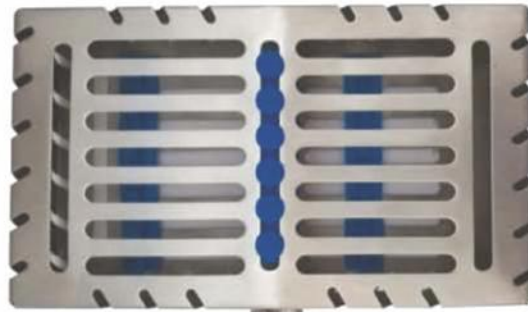

SS-2891

# IMPLANTOLOGY

- Инструменты для имплантологии
- Implantologie
- Implantologie
- Инструменти для імплантології
- Implantologia
- زراعة الأسنان

Set of 5 Composite Gold Tip Instruments  
SS-2892



Set of 4 Composite Blue Tip Instruments  
SS-2893

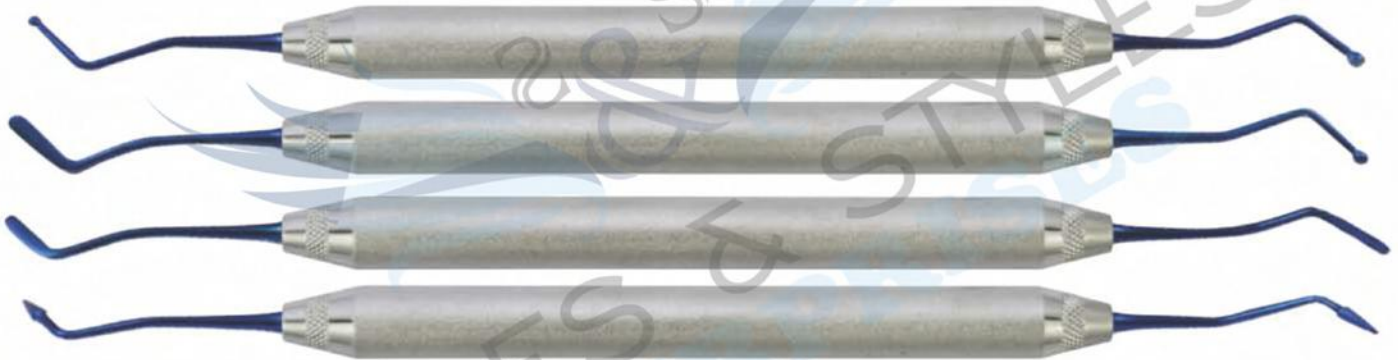

Set of 3 Composite Blue Tip Instruments  
SS-2894



Set of 2 Composite Blue Tip Instruments  
SS-2895



SS-2896 Periosteal Elevators Molt # 9

SS-2897 Endodontic explorer DG # 16



## IMPLANTOLOGY

- Инструменты для имплантологии
- Implantologie
- Implantologie
- Инструменти для імплантології
- Implantologia
- زراعة الأسنان

### VISTA TUNNELING INSTRUMENTS SET



SS-2898



SS-2899



SS-2900



SS-2901



SS-2902



SS-2903



SS-2904



# IMPLANTOLOGY

- Инструменты для имплантологии
- Implantologie
- Implantologie

- Інструменти для імплантології
- Implantologia
- زراعة الأسنان



**SS-2905**  
used for elevation of sinus membrane



**SS-2906**  
used for elevation of sinus membrane

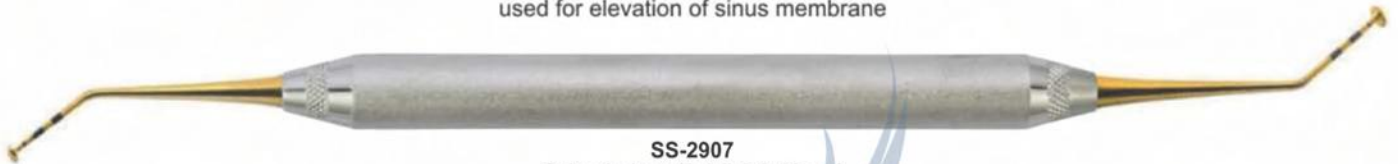

**SS-2907**  
Cobra in / out (2-4-5-6-8-10mm)



**SS-2908**  
Cobra 3.5mm



**SS-2909**  
sinus 4.8 / 5.8 (2-4-5-6-8-10mm)



**SS-2910**  
sinus 2.8 / 3.8 (2-4-5-6-8-10mm)



**SS-2911**  
Bone Graft 3.8SP / 2.8mm (2-4-5-6-8-10mm)



**SS-2912**  
Cobra in / out (2-4-5-6-8-10mm)



**SS-2913**  
Cobra 3.5mm



**SS-2914**  
Gold Color Set Dental Oral Implantology Sinus Set of 10 Pcs with cassette



## IMPLANTOLOGY

- Инструменты для имплантологии
- Implantologie
- Implantologie
- Инструменти для імплантології
- Implantologia
- زراعة الأسنان



**SS-2915**  
Sinus Lift elevator 1



**SS-2916**  
Sinus Lift elevator 2



**SS-2917**  
Sinus Lift elevator 3



**SS-2918**  
Sinus Lift elevator 4



**SS-2919**  
Sinus Lift elevator 5



**SS-2920**  
Sinus Lift elevator 6



**SS-2921**  
Sinus Lift Elevators Set of 7 Pcs  
with cassette

# IMPLANTOLOGY

- Инструменты для имплантологии
- Implantologie
- Implantologie
- Инструменти для імплантології
- Implantologia
- زراعة الأسنان

## Sinus Left Elevator Set of 10 Pcs





## IMPLANTOLOGY

- Инструменты для имплантологии
- Implantologie
- Implantologie
- Инструменти для імплантології
- Implantologia
- زراعة الأسنان

### Blue Titanium Coated Bone Grafting Instruments



**SS-2932**

Bone Graft 1.0 / 1.7 mm Titanium 8. 11. 13. 15. 18 mm



**SS-2933**

Bone Graft 1.0 / 2.0 mm Titanium 8. 11. 13. 15. 18 mm



**SS-2934**

Bone Graft 2.4 / 2.7 mm Titanium 8. 11. 13. 15. 18 mm



**SS-2935**

Bone Graft 3.3 / 4.0 mm Titanium 8. 11. 13. 15. 18 mm



**SS-2936**

Bone Graft 3.3 / 4.0 mm Titanium Coated Tips



**SS-2937**

Bone Graft / Carrier Titanium 8. 11. 13. 15. 18 mm



**SS-2938**

Blue Titanium Coated Bone Grafting Instruments Set of 7 Pcs with cassette

# IMPLANTOLOGY

- Инструменты для имплантологии
- Implantologie
- Implantologie

- Инструменти для имплантології
- Implantologia
- زراعة الأسنان



SS-2939  
Fig. 1



SS-2940  
Fig. 2



SS-2941  
Fig. 3



SS-2942  
Fig. 4



SS-2943  
Fig. 5



SS-2944  
Fig. 6



SS-2945



SS-2946



SS-2947



SS-2948

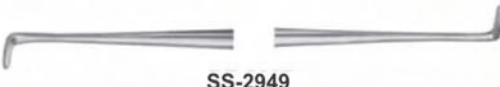

SS-2949

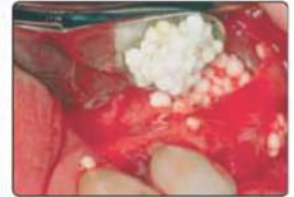
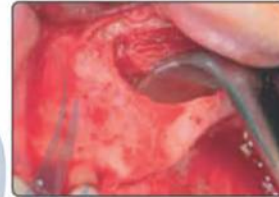

**Flexible Sinus-Lift Curettes – for an optimum sensitivity during the direct lift procedure**  
The perforation of the Schneiderian membrane is a complication that often occurs during a maxillary sinus floor augmentation procedure. The Sinus-Lift Instruments increase the sensitivity by blunt and flexible working tips with "Swing-Effect". Because of their special shapes and the characteristic of the stainless steel between the handle and the active part, light pressure is cushioned and gives the operator a direct and sensitive response. At the same time the risk to perforate the Schneiderian membrane is reduced to a minimum. Already at the development the focus was a practicable handling. Because of varying angulations and shapes of the active parts also in difficult areas they are easy to navigate also in difficult areas. The line of curettes consists of six different figures for every situation. They are complemented by spoon and condenser to place the bone graft.



The "Schneider's Membrane" of the sinus can be detached with curette by 1–2mm along the total cortical bone.



Curette is particularly useful in the lower part for detaching the membrane further. The same goes for the caudal area, especially when the membrane is 4–5 mm above the base of the maxillary sinus and the maxillary sinus is built up with granular material.



Curette makes it possible to lift the membrane further in mesial region. One working tip is especially designed for the right maxillary sinus and the other for the left maxillary sinus.



With curette the sinus membrane is further elevated in the upper and posterior part of the maxillary sinus wall.



With curette the sinus membrane is further detached over a broad area in the inner region, especially along the roof of the palate.



## IMPLANTOLOGY

- Инструменты для имплантологии
- Implantologie
- Implantologie
- Инструменти для імплантології
- Implantologia
- زراعة الأسنان

### IMPLANT SINUS LIFT INSTRUMENTS HOLLOW HANDLE 9.5MM LENGTH 170MM

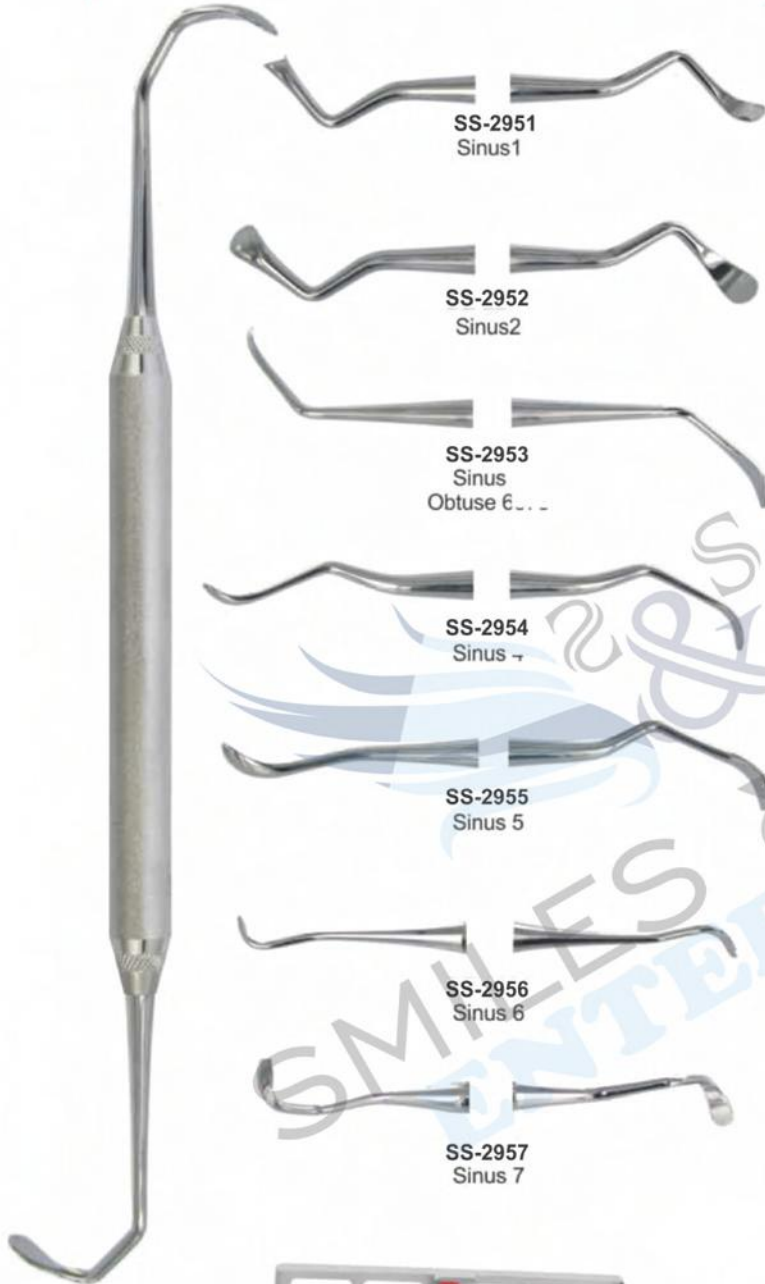

SS-2950  
Acute 6577

SS-2951  
Sinus1

SS-2952  
Sinus2

SS-2953  
Sinus  
Obtuse 6577

SS-2954  
Sinus 4

SS-2955  
Sinus 5

SS-2956  
Sinus 6

SS-2957  
Sinus 7

### SINUS LIFT INSTRUMENTS HOLLOW HANDLE 9.5MM LENGTH 170MM



SS-2960  
Sinuslift 2

SS-2961  
Sinuslift 3

SS-2962  
Sinuslift 4

SS-2963  
Sinusl

SS-2964  
Sinusl

SS-2965  
Membrane  
3Positioning 1

SS-2966  
Condenser 1

SS-2959  
Sinuslift 1



9 Pcs of Set  
SS-2958



9 Pcs of Set  
SS-2967

# IMPLANTOLOGY

- Инструменты для имплантологии
- Implantologie
- Implantologie

- Инструменти для имплантології
- Implantologia
- زراعة الأسنان

## IMPLANT SINUS LIFT INSTRUMENTS PERIODONTAL SURGERY SURGICAL CHISELS KRAMER NEVINS SINUS LIFT

## SURGICAL CHISELS



SS-2968  
TG



SS-2969 SOLT3/4



SS-2976 13K/TG



SS-2970 TGO



SS-2977  
13K/TG Titanium



SS-2971 OCH3



SS-2978 13K/TG



SS-2972 OCH4



SS-2979  
13KL/R Titanium



SS-2973 FEDI1



SS-2980 13KL 4/6mm  
Titanium Available



SS-2974 FEDI2



SS-2975 FEDI3



SS-2981  
Cassette For Instruments



## IMPLANTOLOGY

- Инструменты для имплантологии
- Implantologie
- Implantologie
- Инструменти для імплантології
- Implantologia
- زراعة الأسنان

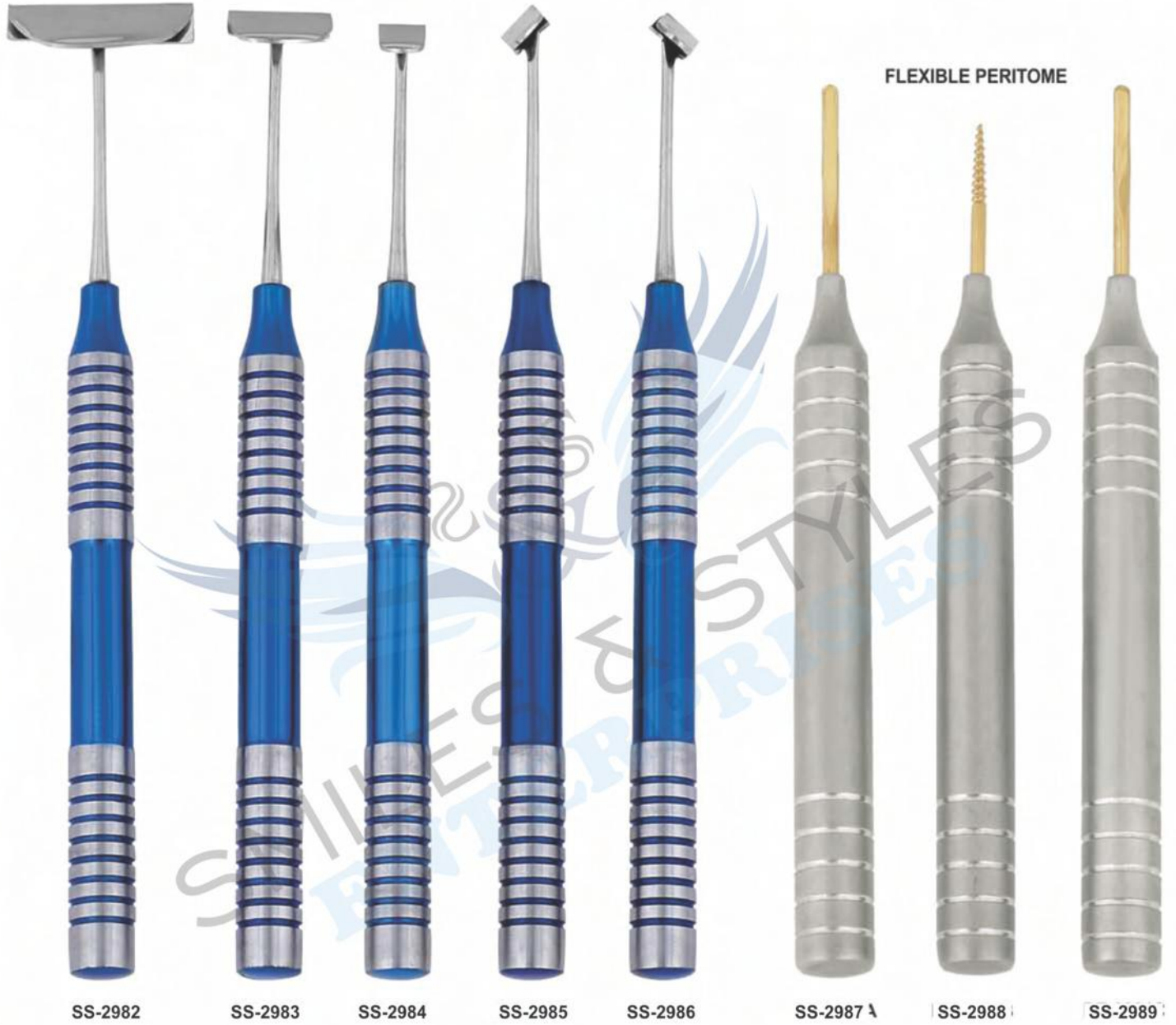

Soft Brushing Kit Set of 6 Pcs



# IMPLANTOLOGY

- Инструменты для имплантологии
- Implantologie
- Implantologie

- Инструменти для імплантології
- Implantoloia
- زراعة الأسنان

## SINUS ELEVATOR & MEMBRANE LIFT TIPS



**SS-2990**  
Membrane Detach Elevator



**SS-2991**  
Membrane Elevator



**SS-2992**  
Membrane Elevator



**SS-2993**  
Membrane Elevator



**SS-2994**  
Membrane Elevator



**SS-2995**  
Bone Graft Packer



**SS-2996 A** Pt2 Titanium  
A/V Regular



**SS-2996 B** Pt1 Titanium  
A/V Regular



**SS-2996 C** Pt3 Titanium Angel S/E



**SS-2996 D** Pt4 Titanium STR S/E



**SS-2996 E** Pt5 Titanium TG CVD S/E



**SS-2997**  
Sinus Left Elevator & Membrane Lift Tips 3  
set of 7 Pcs



## IMPLANTOLOGY

- Инструменты для имплантологии
- Implantologie
- Implantologie
- Инструменти для імплантології
- Implantologia
- زراعة الأسنان

### MIXING SPATULA WITH SHOVEL



**SS-2998**  
Bone Carrier  
Titanium



**SS-2999**  
Raspator, Prichard  
Length 180 mm,  
10 mm hollow handle,  
double-ended  
10.5 mm | 4.5 mm,



**SS-3000**  
Raspator, Prichard  
Length 180 mm,  
10 mm hollow handle,  
double ended



**SS-3001**  
Raspator, Prichard  
Length 180 mm,  
10 mm hollow handle,  
double-ended  
10.5 mm | 4.5 mm,



**SS-3002**  
Mixing Spatula  
with shovel  
17cm



**SS-3003**  
Mixing Spatula  
with shovel  
18.5cm



**SS-3004**  
Graft Material Spoon  
Concave Tip For  
Larger Grafts

# IMPLANTOLOGY

- Инструменты для имплантологии
  - Implantologie
  - Implantologie
- Инструменти для имплантології
  - Implantologia
  - زراعة الأسنان

## BONE GRAFTING INSTRUMENTS COMPACTOR /TAMPERS

Product offering includes instruments for harvesting, mixing and compacting bone Provides clinicians with the proper instrumentation for bone grafting procedures Weighted bone basin Prevents tipping and spilling of bone and other materials during mixing



**SS-3005**  
Graft Packer, Concave Tips DE 4/6mm



**SS-3006**  
Bone Spoon/ Packer DE 3mm



**SS-3007**  
Blade and pusher Length 180 mm, for straight or angled, blade: 15 x 5 mm, pusher: 4 mm diameter Straight



**SS-3008**  
Blade and pusher Length 180 mm, for straight or angled, blade: 15 x 5 mm, pusher: 4 mm diameter angular



**SS-3009**  
Spoon and pusher Length 180 mm, for angled spoon: 10 x 5 mm, pusher: diameter 3 mm



**SS-3010**  
Graft Packer, Smooth Tips DE 5/8mm



**SS-3011**  
Graft Packer, Serrated Tips DE 3/4mm



**SS-3012**  
Graft Packer, Serrated Tips DE 6/8mm



**SS-3013**  
Titanium graft packer/ placement site depth gauge 3.3mm & 4.0mm Diameter tips Marked at 8, 11, 13, 15 & 18mm



**SS-3014**  
Tamber Length 170 mm, for bone material, double-ended, diameter 3.2 mm (2-4-6-8-10) and diameter 2.5mm (2-4-6-8-10)



## IMPLANTOLOGY

- Инструменты для имплантологии
- Implantologie
- Implantologie
- Инструменти для імплантології
- Implantologia
- زراعة الأسنان

### SPOON AND PUSHER (TRINOVO)

Trinovo handle, different workers, for bone material, high-grade medical stainless steel, corrosion-resistant



# IMPLANTOLOGY

- Инструменты для имплантологии
- Implantologie
- Implantologie

- Инструменти для імплантології
- Implantoloia
- زراعة الأسنان

Hollow Handle 10mm Length 170mm





## IMPLANTOLOGY

- Инструменты для имплантологии
- Implantologie
- Implantologie
- Инструменти для імплантології
- Implantologia
- زراعة الأسنان

### TISSUE MEMBRANE FORCEPS



**SS-3031**  
Tissue Graft Forcep  
Serrated Teeth



**SS-3032**  
Self Locking  
Grooved



**SS-3033**  
Tissue Graft Forcep  
Serrated Teeth



**SS-3034**  
Titanium  
Locking Plier



**SS-3035**  
TC Gripper Carbide  
Tipped Tissue Forceps  
Serrated Carbide Tips  
14.5cm



**SS-3036**  
Adson Carbide  
Tipped Tissue Forceps  
Serrated Carbide Tips  
12cm



**SS-3037**  
Micor Adson 1x2  
Tissue Forcep 12.1cm  
1x2 Teeth - 0.5mm Tips



**SS-3038**  
Adson 7x7  
Tissue Forceps  
7x7 Teeth 12cm



**SS-3039**  
Adson 7x7 Curved  
Tissue Forceps  
7x7 Teeth 12cm



**SS-3040**  
Suture Forceps  
Suture Forceps with  
1.6mm Ring Tip



**SS-3041**  
Debakey Atraumatic  
Tissue Forceps Straight  
Serrated Teeth  
16cm



**SS-3042**  
Debakey Atraumatic  
Tissue Forceps Curved  
Serrated Teeth  
16cm

# IMPLANTOLOGY

- Инструменты для имплантологии
  - Implantologie
  - Implantologie
- Инструменти для имплантології
  - Implantoloia
  - زراعة الأسنان

## TISSUE MEMBRANE FORCEPS



**SS-3043**  
Russian Long  
Tissue Forceps  
Serrated Tip  
20cm



**SS-3044**  
Russian  
Tissue Forceps  
Serrated Tip  
15cm



**SS-3045**  
Tissue Punch Forceps  
To Remove Tissue  
After Using Punch



**SS-3046**  
13.5 cm  
narrow



**SS-3047**  
10.5 cm



**SS-3048**  
13.5 cm  
wide

Membrane tweezers KUEHNE



**SS-3049**  
Pin-Tweezers  
with or without lock,  
length 15 cm,  
with lock



**SS-3050**  
without lock



**SS-3051**  
Haltepinzette with lock  
15,5 cm, for pins, towards  
the tips, etc



**SS-3052**  
Carry Forceps  
15cm



**SS-3053**  
Carry Forceps  
15cm



**SS-3054**  
Carry Forceps  
15cm



# IMPLANTOLOGY

- Инструменты для имплантологии
- Implantologie
- Implantologie
- Инструменти для імплантології
- Implantologia
- زراعة الأسنان

## OSTEOTOME CONVEXES / CONCAVE / CONIQUES

CONVEXES

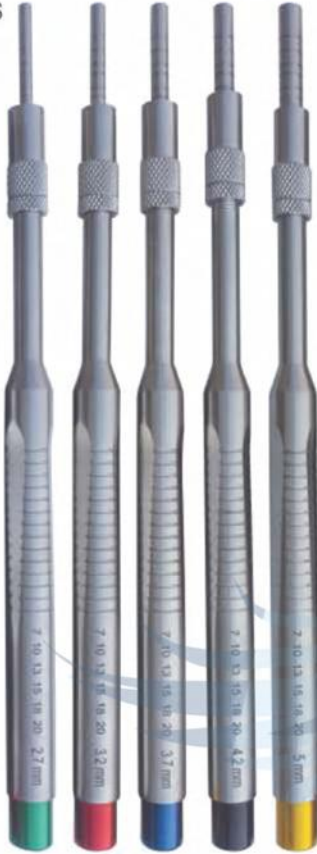

SS-3055  
SET OF 5 PIECES

CONCAVES

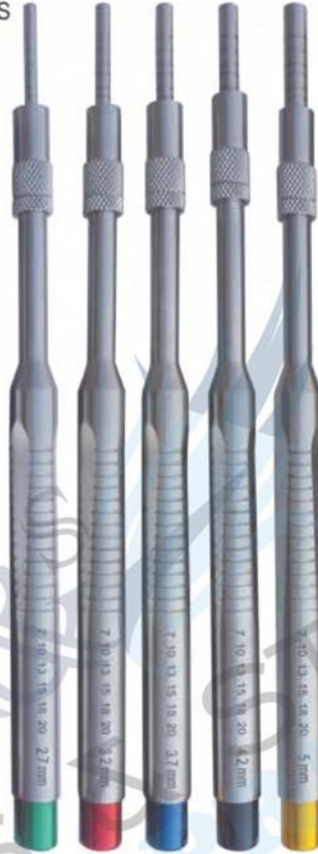

SS-3056  
SET OF 5 PIECES

CONIQUES



SS-3057  
SET OF 5 PIECES

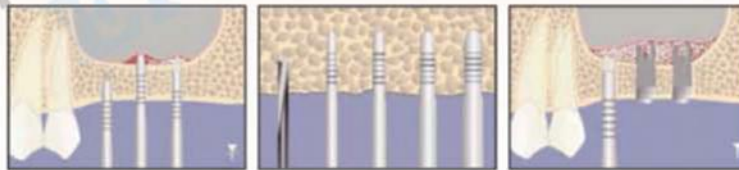

	CONVEXES STRAIGHT	SS-3058	2,7 Ømm	3,2 Ømm	3,7 Ømm	4,2 Ømm	5 Ømm
	CONCAVES STRAIGHT	SS-3059	2,7 Ømm	3,2 Ømm	3,7 Ømm	4,2 Ømm	5 Ømm
	CONIQUES STRAIGHT	SS-3060	2,7 Ømm	3,2 Ømm	3,7 Ømm	4,2 Ømm	5 Ømm

# IMPLANTOLOGY

- Инструменты для имплантологии
- Implantologie
- Implantologia
- زراعة الأسنان

## OSTEOTOME CONVEXES / CONCAVE / CONIQUES



**SS-3061**  
SET OF 5 PIECES

**SS-3062**  
SET OF 5 PIECES

**SS-3063**  
SET OF 5 PIECES

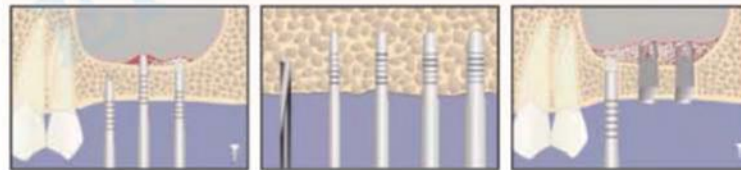

	CONVEXES CURVED	SS-3064	2,7 Ømm	3,2 Ømm	3,7 Ømm	4,2 Ømm	5 Ømm
	CONCAVES CURVED	SS-3065	2,7 Ømm	3,2 Ømm	3,7 Ømm	4,2 Ømm	5 Ømm
	CONIQUES CURVED	SS-3066	2,7 Ømm	3,2 Ømm	3,7 Ømm	4,2 Ømm	5 Ømm



## IMPLANTOLOGY

- Инструменты для имплантологии
- Implantologie
- Implantologie
- Инструменти для імплантології
- Implantologia
- زراعة الأسنان

### BONE SCRAPER STRAIGHT & CURVED



SS-3067  
Bone Scraper  
Straight

SS-3068  
Bone Scraper  
Curved

### TISSUE PUNCH STRAIGHT & CURVED



Tissue Punch  
Straight

Tissue Punch  
Curved



SS-3081  
Tissue Punch with pin  
Set of Four Pieces

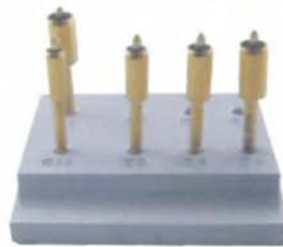

SS-3082  
Tissue Punch  
Set of Five Pieces



SS-3083  
Tissue Punch  
Set of Five Pieces

# IMPLANTOLOGY

- Инструменты для имплантологии
- Implantologie
- Implantologie
- Инструменти для імплантології
- Implantologia
- زراعة الأسنان

## BONE MILL BONE WELL

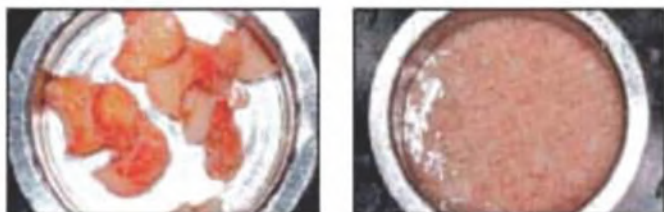



## IMPLANTOLOGY

- Инструменты для имплантологии
- Implantologie
- Implantologie
- Инструменти для імплантології
- Implantologia
- زراعة الأسنان

### TREPHINE

Burs with depth markings are suited for precise and simple transplantation of cylindrical bone grafts as well as for all other bone-extraction tasks.



**SS-3099**  
Trepine Drill  
Set of Eight Pieces



**SS-3100**  
Trepine Drill  
Set of Eight Pieces

### BONE INJECTORS, COLLECTORS & SUCTION TUBE

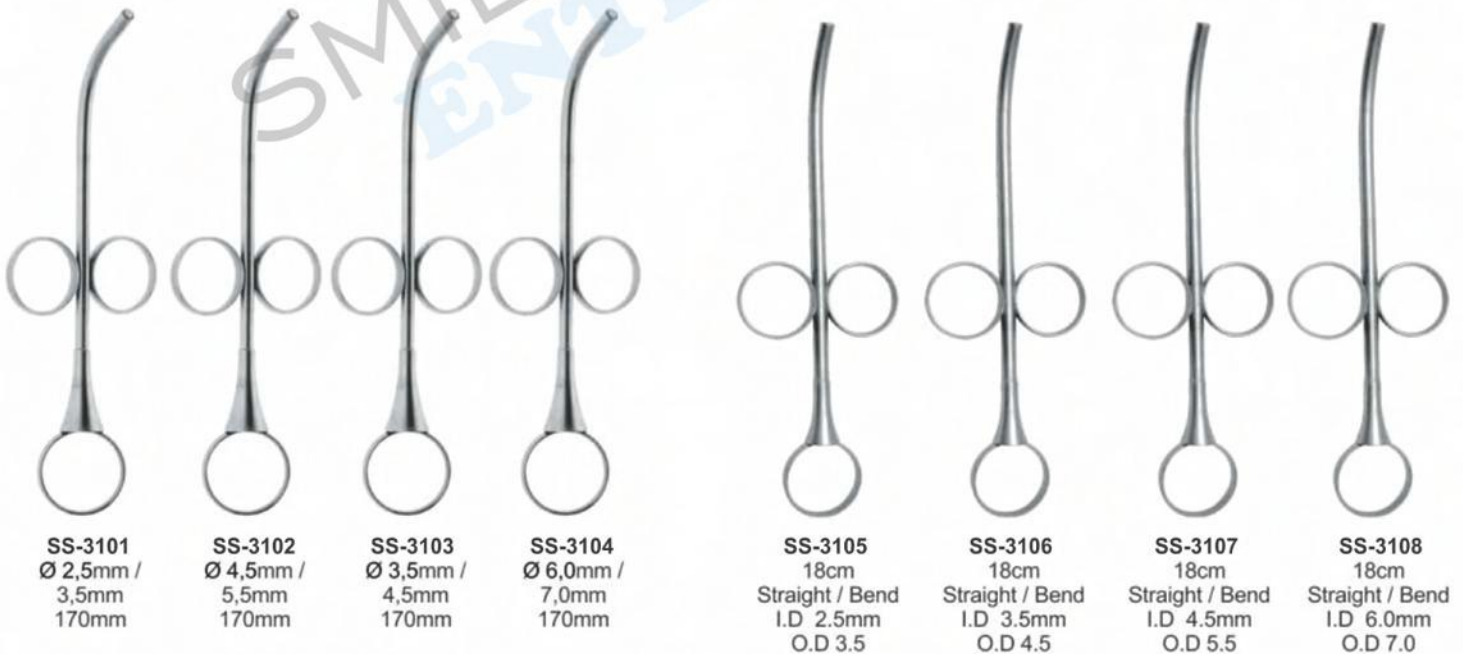

# IMPLANTOLOGY

- Инструменты для имплантологии
- Implantologie
- Implantologie
- Инструменти для имплантології
- Implantologia
- زراعة الأسنان

## BONE EXPANDER SCREW & SURGICAL KITS



Ø2.0mm    Ø2.5mm    Ø2.8mm

**SS-3109** Short Implant Drills



Ø3.2mm    Ø3.65mm    Ø4.2mm    Ø5.2mm

**SS-3110** Long Implant Drills



**SS-3111**

**Bone Universal Kit**

Drill: 2mm, 2.8mm, 3.2mm, 3.65mm, 4.2mm, 4.5mm, 4.8mm, 5.2mm  
 Trephines Bit: 3.0mm, 4.0mm, 5.0mm, 6.0mm, 7.0mm, 8.0mm, 9.0mm, 10mm.  
 Driver: 2.5mm, 2.5mm Hand Pcs, 1.25mm, 1.25mm Hand Pcs  
 Short Driver 2.5mm, Long Driver 2.5mm  
 1.25mm, Short Hex Driver Hand Pcs  
 1.25mm, Long Hex Driver Hand Pcs, Torque Wrench 4.0mm



**SS-3112**

**Bone Expander Kit**

Expander: 2.6mm, 3.0mm, 3.4mm, 3.8mm, 4.3mm  
 Ratchet Driver, Parallel Pin  
 Pilot Drill, Drill 1.4mm, Drill Driver 4mm  
 Hand Driver 4mm, Ratchet 4.0mm



**SS-3113**

**Bone Universal Kit**

Drill: 2mm, 2.8mm, 3.2mm, 3.65mm, 4.2mm, 4.5mm, 4.8mm, 5.2mm  
 Trephines Bit: 3.0mm, 4.0mm, 5.0mm, 6.0mm, 7.0mm, 8.0mm, 9.0mm, 10mm.

**Bone Compression:**

2mm, 3.3mm, 2.8mm, 4.2mm, 3mm, 3.5mm  
 Driver: 2.5mm, 2.5mm Hand Pcs  
 1.25mm, 1.25mm Hand Pcs  
 Short Driver 2.5mm  
 Long Driver 2.5mm  
 1.25mm, Short Hex Driver Hand Pcs  
 1.25mm, Long Hex Driver Hand Pcs  
 Torque Wrench 6.35mm 1 Pcs

**SS-3114**

**Conical Drills: 20 Pcs**

Tissue Punches: 3.0mm, 3.50mm, 4.0mm, 4.5mm, 5.0mm, 6.0mm, 6.50mm  
 Bone Expander: 1.6/3.8mm, 1.9/3.0mm, 2.1/3.6mm, 2.6/3.8mm, 2.9/4.3mm  
 Drill Adapter: 1 Pcs  
 1.25mm, 2.50mm Hex Driver Hand Pcs



**Pilot Drill: 1.6mm**

Drill Bit: 1.4mm, 1.6mm, 1.8mm, 2.0mm, 2.2mm  
 Ratchet Driver: 4mm/6.35, 1.25/2.50  
 Rimer: 3.2/4.7mm, 3.7/4.7mm  
 Parallel Pin: 4.5mm, 2.5mm  
 Double step Drill: 2.4/2.8mm  
 Depth Gauge: 1 Pcs  
 Torque Wrench 6.35mm Universal: 1 Pcs



## IMPLANTOLOGY

- Инструменты для имплантологии
- Implantologie
- Implantologie
- Инструменти для імплантології
- Implantologia
- زراعة الأسنان

### KEYS FOR IMPLANT SCREW



SS-3115



SS-3116



SS-3117



SS-3118

### TORQUE WRENCH & RATCHET



SS-3119 Star Torque Wrench 6.35mm Universal



SS-3120 Round Torque Wrench 4.0mm Universal



SS-3121 Hex Driver With 4.0mm Driver



SS-3122 Star Torque Wrench 6.35mm Universal



SS-3123 Hex Torque Wrench 4.00mm Universal



SS-3124 Star Torque Wrench 6.35mm Universal



SS-3125 Star Torque Wrench 6.35mm Universal



SS-3126 Star Torque Wrench 6.35mm Universal



SS-3127 Star Torque Wrench 6.35mm Universal



SS-3128 Star Torque Wrench 6.35mm Universal



SS-3129 Star Ratchet Wrench 6.35mm Universal



SS-3130 Star Ratchet Wrench 6.35mm Universal



DE-2399 Star Ratchet Wrench 6.35mm Universal



DE-2400 Star Ratchet Wrench 4.0mm Universal



DE-2401 Round Ratchet Wrench 4.0mm Universal



DE-2402 Round Ratchet Wrench 3.35mm Universal



DE-2403 Star Ratchet Wrench 4.0mm Universal



DE-2404 Star Ratchet Wrench 6.35mm Universal

# IMPLANTOLOGY

- Инструменты для имплантологии
- Implantologie
- Implants
- زراعة الأسنان



**SS-3131**  
Suction Cannula Kit  
with 3 Needles



Suction Pipe



Suction Needle  
1mm



Suction Needle  
1.5mm



Suction Needle  
2mm



**SS-3132**  
17.5cm

**SS-3133**  
18cm

**SS-3134**  
coarse  
Ø 5mm

Suction tubes to collect  
the extracted  
bone material  
180mm



**SS-3135**  
fine  
Ø 9mm



**SS-3136**  
Suction  
Tubes  
180mm

**SS-3137**  
Suction  
Tubes  
180mm

**SS-3138**  
Suction  
Tubes  
180mm



**SS-3140**  
Ø 3 mm  
length 180mm  
**SS-3141**  
Ø 4 mm  
length 180mm  
**SS-3142**  
Ø 5 mm  
length 180mm

**SS-3139**  
Fig. 6FR  
Frazier  
15 cm - Ø 2 mm



## IMPRESSION TRAYS

- Оттисные ложки
- Porte-empreinte
- Abdrucklöffel
- Відбиткові ложки
- Cubetas para impresiones
- صواني الانطباع

### PERFORATED WITH RIM LOCK

Set of 06 Pcs



SS-3143 SET OF 06 PCS  
Upper: S, M, L  
Lower: S, M, L

### PERFORATED WITH RIM LOCK

Set of 8 Pcs



SS-3144 SET OF 08 PCS  
Upper: XS, S, M, L  
Lower: XS, S, M, L

SS-3145 SET OF 08 PCS  
Upper: S, M, L, XL  
Lower: S, M, L, XL

SS-3146 SET OF 10 PCS  
Upper: XS, S, M, L, XL  
Lower: XS, S, M, L, XL

## IMPRESSION TRAYS

- Оттисные ложки
  - Porte-empreinte
  - Abdrucklöffel
- Відбиткові ложки
  - Cubetas para impresiones
  - صواني الانطباع

### SOLID WITH RIM LOCK

Set of 6 Pcs

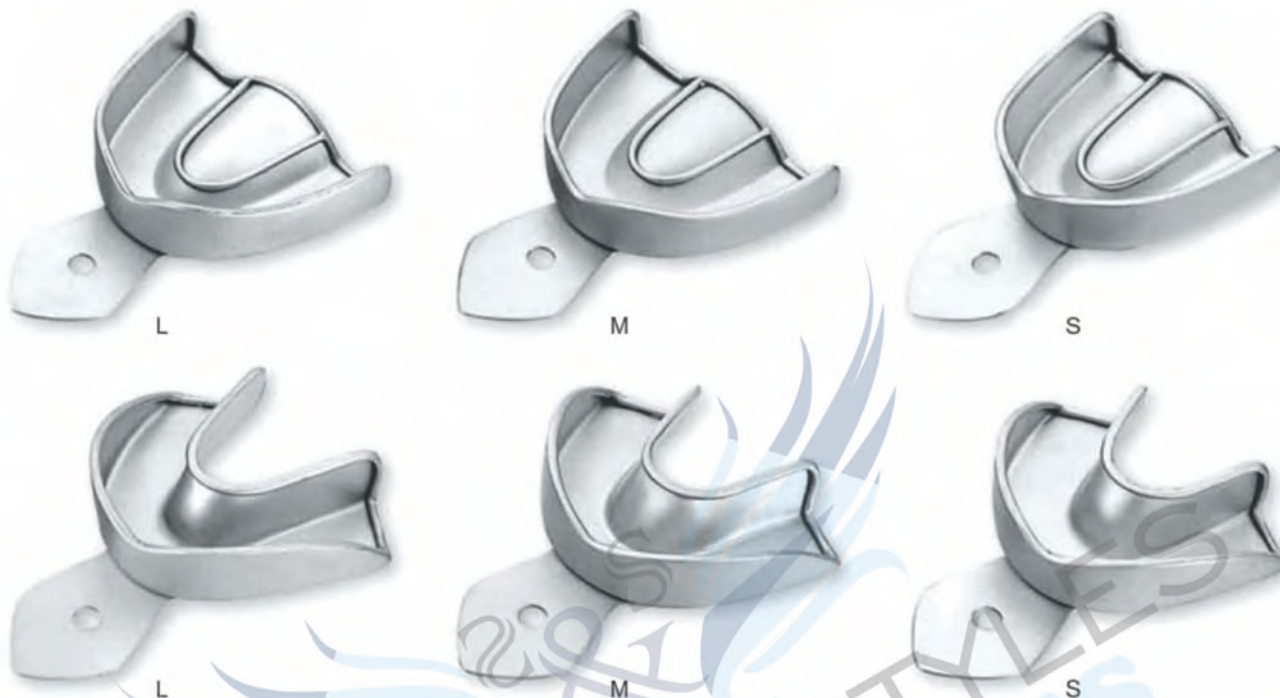

**SS-3147 SET OF 06 PCS**  
Upper: S, M, L  
Lower: S, M, L

### SOLID WITH RIM LOCK

Set of 8 Pcs

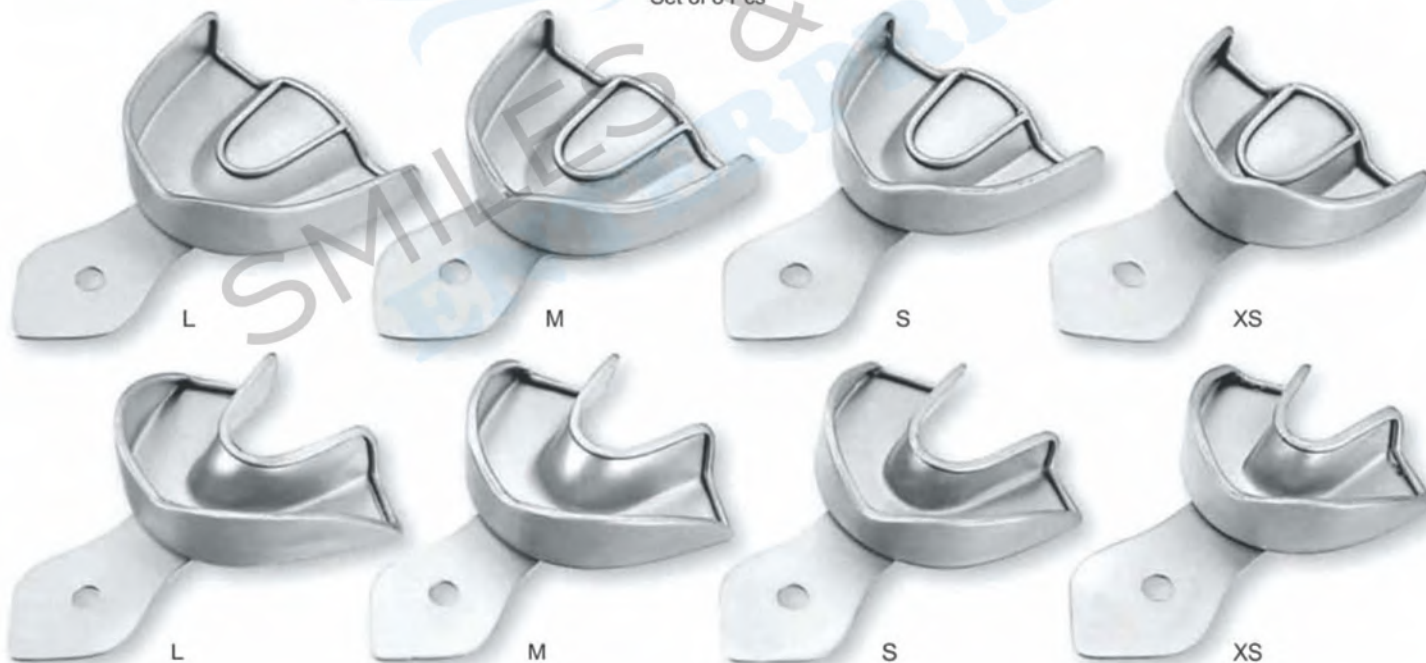

**SS-3148 SET OF 08 PCS**  
Upper: XS, S, M, L  
Lower: XS, S, M, L

**SS-3149 SET OF 08 PCS**  
Upper: S, M, L, XL  
Lower: S, M, L, XL

**SS-3150 SET OF 10 PCS**  
Upper: XS, S, M, L, XL  
Lower: XS, S, M, L, XL



## IMPRESSION TRAYS

- Оттисные ложки
- Porte-empreinte
- Abdrucklöffel
- Відбиткові ложки
- Cubetas para impresiones
- صوتاتي الانطباع

### PERFORATED FULL DENTURE

Set of 8 Pcs

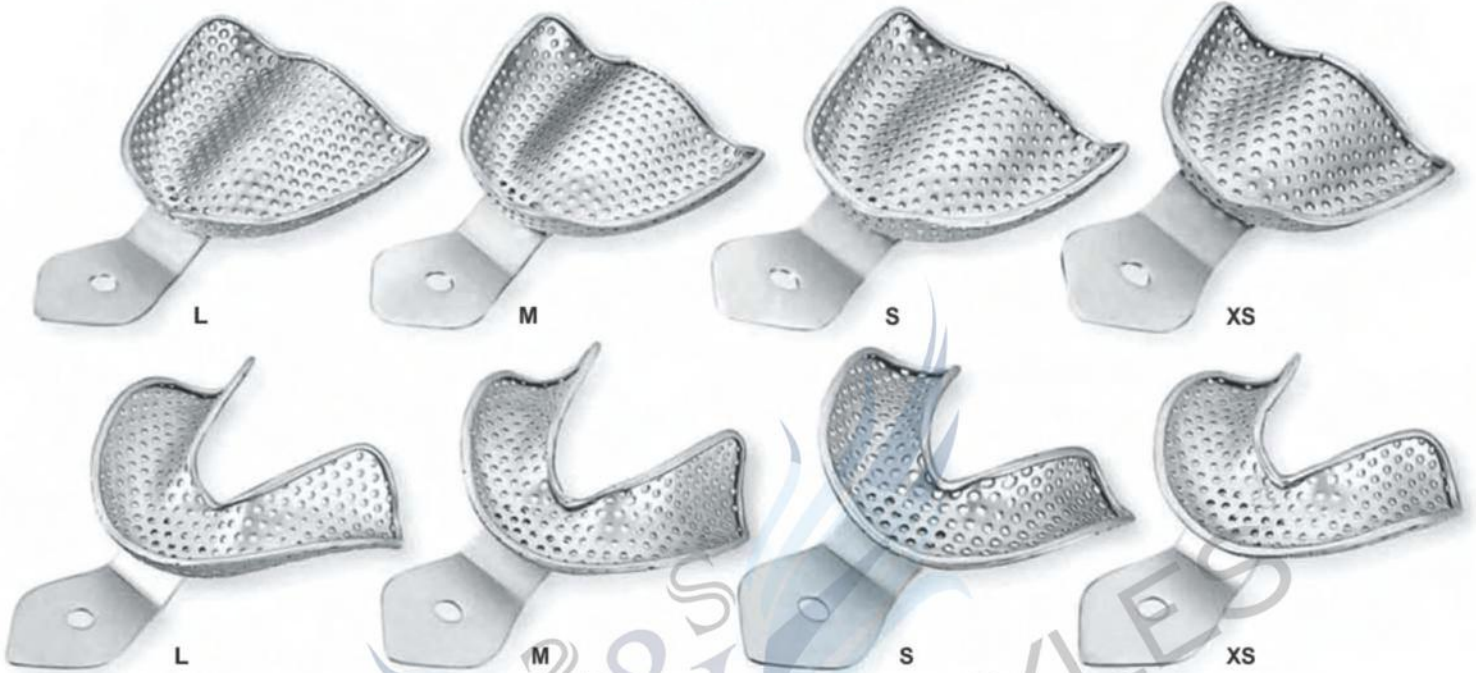

SS-3151 SET OF 08 PCS  
Upper: S, M, L, XL  
Lower: S, M, L, XL

SS-3152 SET OF 08 PCS  
Upper: S, M, L  
Lower: S, M, L

### SOLID FULL DENTURE

Set of 8 Pcs

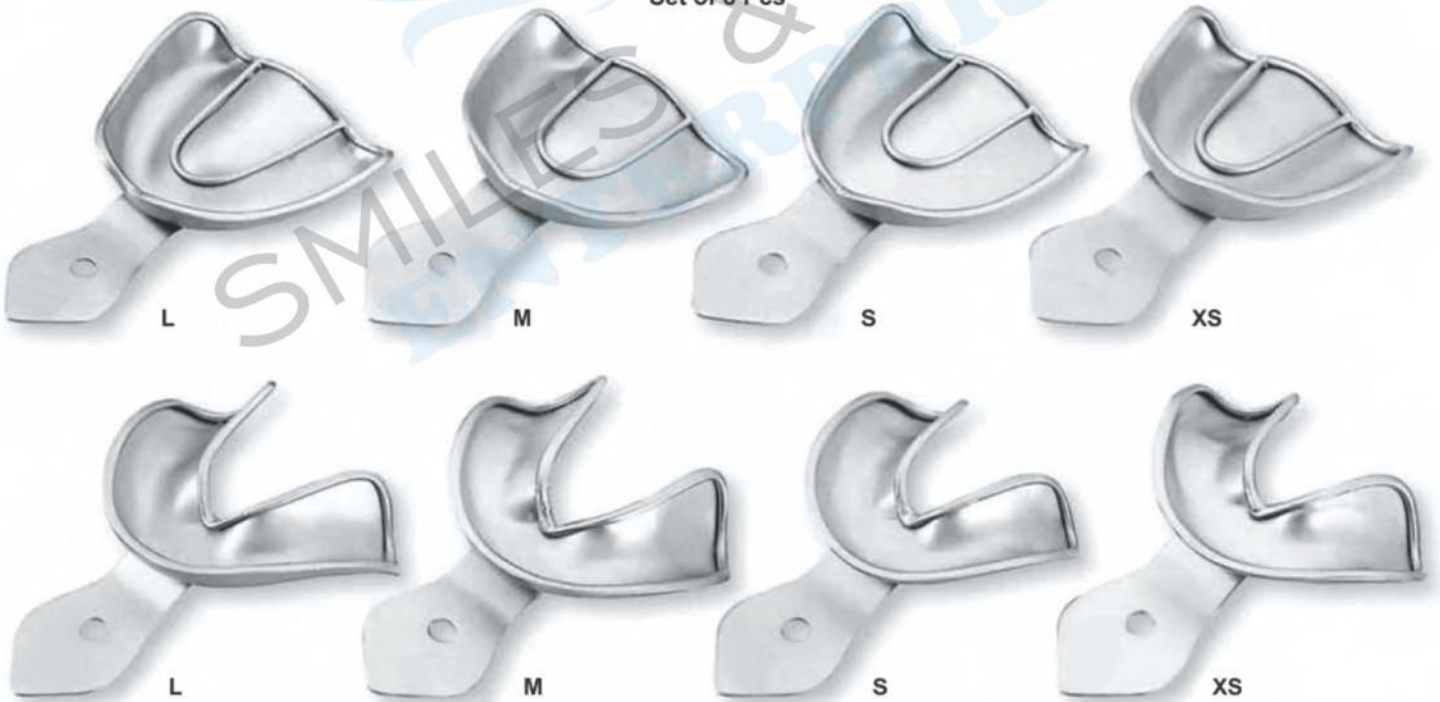

SS-3153 SET OF 08 PCS  
Upper: S, M, L, XL  
Lower: S, M, L, XL

SS-3154 SET OF 06 PCS  
Upper: S, M, L  
Lower: S, M, L

# IMPRESSION TRAYS

- Оттисные ложки
  - Porte-empreinte
  - Abdrucklöffel
- Відбиткові ложки
  - Cubetas para impresiones
  - صواني الانطباع

## Perforated Without Rim Lock



## Solid With Rim Lock

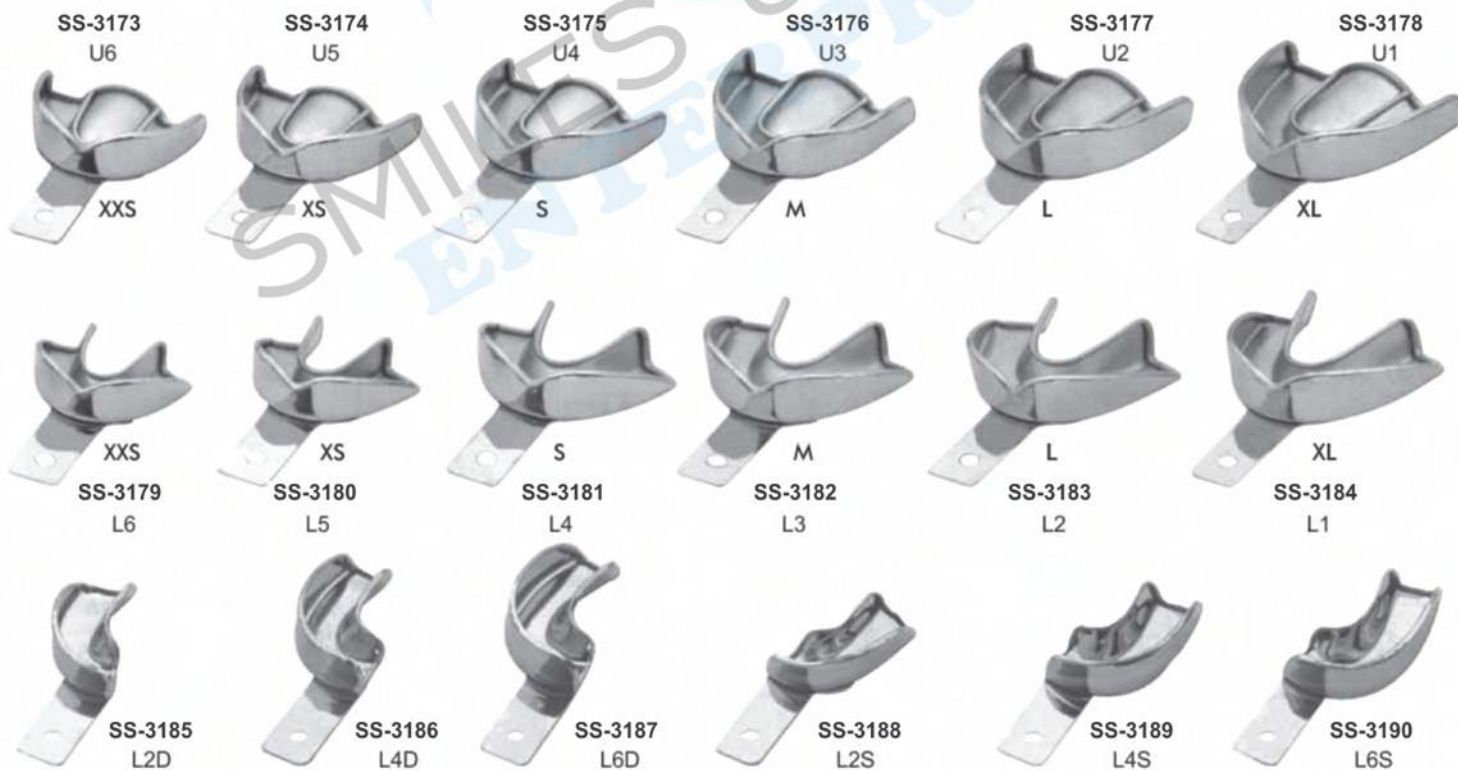



## HOLLOWWARE INSTRUMENTS



# HOLLOWARE INSTRUMENTS



**Scalers Tray**  
SS-3191 200 x 100 mm



**Scalers Trays**  
SS-3192 205 x 115 x 17 mm  
SS-3193 205 x 152 x 17 mm  
SS-3194 290 x 115 x 17 mm

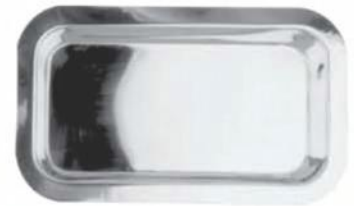

**Instruments Trays**  
SS-3195 200 x 110 x 30 mm  
SS-3196 215 x 115 x 35 mm  
SS-3197 220 x 130 x 30 mm  
SS-3198 230 x 125 x 35 mm  
SS-3199 245 x 140 x 40 mm  
SS-3200 285 x 160 x 45 mm  
SS-3201 315 x 175 x 50 mm  
SS-3202 330 x 185 x 50 mm



**Instruments Trays**  
SS-3203 150 x 100 x 50 mm  
SS-3204 200 x 100 x 50 mm  
SS-3205 220 x 120 x 50 mm  
SS-3206 240 x 140 x 50 mm  
SS-3207 200 x 150 x 50 mm  
SS-3208 250 x 200 x 50 mm  
SS-3209 300 x 250 x 50 mm  
SS-3210 300 x 200 x 50 mm  
SS-3211 350 x 250 x 50 mm  
SS-3212 400 x 300 x 50 mm  
SS-3213 450 x 300 x 50 mm  
SS-3214 450 x 350 x 50 mm



**Instruments Trays With Lid**  
SS-3215 150 x 100 x 50 mm  
SS-3216 200 x 100 x 50 mm  
SS-3217 220 x 120 x 50 mm  
SS-3218 240 x 140 x 50 mm  
SS-3219 200 x 150 x 50 mm  
SS-3220 250 x 200 x 50 mm  
SS-3221 300 x 250 x 50 mm  
SS-3222 300 x 200 x 50 mm  
SS-3223 350 x 250 x 50 mm  
SS-3224 400 x 300 x 50 mm  
SS-3225 450 x 300 x 50 mm  
SS-3226 450 x 350 x 50 mm



**Mayo Tray Perforated**  
SS-3227 150 x 100 x 25 mm  
SS-3228 200 x 100 x 25 mm  
SS-3229 220 x 120 x 25 mm  
SS-3230 240 x 140 x 25 mm  
SS-3231 200 x 150 x 25 mm  
SS-3232 250 x 200 x 25 mm  
SS-3233 300 x 250 x 25 mm  
SS-3234 300 x 200 x 25 mm  
SS-3235 350 x 250 x 25 mm  
SS-3236 400 x 300 x 25 mm  
SS-3237 450 x 300 x 25 mm  
SS-3238 450 x 350 x 25 mm



**Scaler Tray**  
SS-3239 200 x 115 mm  
SS-3240 205 x 150 mm  
SS-3241 290 x 150 mm  
SS-3242 300 x 200 mm



**Instruments Tray Perforated**  
SS-3243 150 x 100 x 50 mm  
SS-3244 200 x 100 x 50 mm  
SS-3245 220 x 120 x 50 mm  
SS-3246 240 x 140 x 50 mm  
SS-3247 200 x 150 x 50 mm  
SS-3248 250 x 200 x 50 mm  
SS-3249 300 x 250 x 50 mm  
SS-3250 300 x 200 x 50 mm  
SS-3251 350 x 250 x 50 mm  
SS-3252 400 x 300 x 50 mm  
SS-3253 450 x 300 x 50 mm  
SS-3254 450 x 350 x 50 mm



## HOLLOWARE INSTRUMENTS

### Sterilizing boxes & instruments Trays



#### Instruments Box with Hooks

SS-3255	170 x 70 x 30 mm
SS-3256	180 x 80 x 40 mm
SS-3257	200 x 100 x 40 mm
SS-3258	200 x 100 x 50 mm
SS-3259	220 x 120 x 50 mm
SS-3260	250 x 150 x 50 mm
SS-3261	250 x 200 x 50 mm
SS-3262	300 x 150 x 60 mm
SS-3263	300 x 200 x 50 mm
SS-3264	350 x 250 x 50 mm
SS-3265	400 x 200 x 100 mm
SS-3266	450 x 250 x 50 mm



#### Instruments Box

SS-3267	170 x 70 x 30 mm
SS-3268	180 x 80 x 40 mm
SS-3269	200 x 100 x 40 mm
SS-3270	200 x 100 x 50 mm
SS-3271	220 x 120 x 50 mm
SS-3272	250 x 150 x 50 mm
SS-3273	250 x 200 x 50 mm
SS-3274	300 x 150 x 60 mm
SS-3275	300 x 200 x 50 mm
SS-3276	350 x 250 x 50 mm
SS-3277	400 x 200 x 100 mm
SS-3278	450 x 250 x 50 mm



#### Instruments Box Perforated

SS-3279	170 x 70 x 30 mm
SS-3280	180 x 80 x 40 mm
SS-3281	200 x 100 x 40 mm
SS-3282	200 x 100 x 50 mm
SS-3283	220 x 120 x 50 mm
SS-3284	250 x 150 x 50 mm
SS-3285	250 x 200 x 50 mm
SS-3286	300 x 150 x 60 mm
SS-3287	300 x 200 x 50 mm
SS-3288	350 x 250 x 50 mm
SS-3289	400 x 200 x 100 mm
SS-3290	450 x 250 x 50 mm



#### Gloves Box

SS-3291	300 x 150 mm
---------	--------------



#### Catheters Tray with lid

SS-3292	200 x 60 x 40 mm
SS-3293	200 x 90 x 40 mm
SS-3294	320 x 95 x 50 mm
SS-3295	328 x 90 x 50 mm
SS-3296	365 x 90 x 50 mm
SS-3297	440 x 115 x 50 mm



#### Box With Filter

SS-3298	100 x 50 mm
SS-3299	250 x 150 mm
SS-3300	150 x 65 mm
SS-3301	200 x 100 mm
SS-3302	300 x 200 mm



#### Instruments Trays With Cover

SS-3303	210 x 110 x 50 mm
SS-3304	240 x 160 x 50 mm
SS-3305	300 x 180 x 50 mm
SS-3306	360 x 210 x 50 mm
SS-3307	400 x 230 x 55 mm

#### Instruments Trays Without Cover

SS-3308	210 x 110 x 50 mm
SS-3309	240 x 160 x 50 mm
SS-3310	300 x 180 x 50 mm
SS-3311	360 x 210 x 50 mm
SS-3312	400 x 230 x 55 mm



#### Instruments Box with lid

SS-3313	170 x 70 x 30 mm
SS-3314	180 x 80 x 40 mm
SS-3315	200 x 100 x 40 mm
SS-3316	200 x 100 x 50 mm
SS-3317	220 x 120 x 50 mm
SS-3318	250 x 150 x 50 mm
SS-3319	250 x 200 x 50 mm
SS-3320	300 x 150 x 60 mm
SS-3321	300 x 200 x 50 mm
SS-3322	350 x 250 x 50 mm
SS-3323	400 x 200 x 100 mm
SS-3324	450 x 250 x 50 mm

# HOLLOWARE INSTRUMENTS



**Kidney Tray**  
 SS-3325 160 mm  
 SS-3326 200 mm  
 SS-3327 250 mm  
 SS-3328 280 mm  
 SS-3329 300 mm



**Kidney Tray Shallow**  
 SS-3335 170 mm  
 SS-3336 220 mm  
 SS-3337 240 mm



**Kidney Tray With Cover**  
 SS-3330 160 mm  
 SS-3331 200 mm  
 SS-3332 250 mm  
 SS-3333 280 mm  
 SS-3334 300 mm



**Kidney Tray**  
 SS-3338 160 mm  
 SS-3339 200 mm  
 SS-3340 250 mm  
 SS-3341 280 mm  
 SS-3342 300 mm



**Forceps Jars**  
 SS-3343 30 x 90 mm  
 SS-3344 50 x 100 mm  
 SS-3345 50 x 130 mm  
 SS-3346 50 x 175 mm  
 SS-3347 75 x 100 mm  
 SS-3348 75 x 130 mm  
 SS-3349 75 x 175 mm  
 SS-3350 100 x 175 mm  
 SS-3351 100 x 200 mm



**Methot Jar Without Lid**  
 SS-3352



**Dressing Jar / Cotton Container**  
 SS-3353 80 x 80 mm  
 SS-3354 100 x 60 mm  
 SS-3355 100 x 80 mm  
 SS-3356 100 x 100 mm  
 SS-3357 120 x 80 mm  
 SS-3358 120 x 100 mm  
 SS-3359 150 x 100 mm  
 SS-3360 150 x 150 mm  
 SS-3361 180 x 150 mm  
 SS-3362 180 x 180 mm  
 SS-3363 200 x 200 mm  
 SS-3364 240 x 240 mm



**Sputum Cup**  
 SS-3365



**Dressing Jar With Lid & Knob**  
 SS-3366 80 x 80 mm  
 SS-3367 90 x 90 mm  
 SS-3368 100 x 100 mm  
 SS-3369 120 x 120 mm  
 SS-3370 100 x 130 mm  
 SS-3371 150 x 150 mm  
 SS-3372 125 x 170 mm



**Round Bowls**  
 SS-3373 80 x 35 mm  
 SS-3374 125 x 60 mm





Spirit Lamp  
SS-3375



Spirit Lamp  
SS-3376



Spirit Lamp  
SS-3377



Cotton Holding Jar  
SS-3378



Cotton Holder  
SS-3379



Cotton Holder  
SS-3380



Cotton Wool Dispenser Acc.  
to Methot  
SS-3381



Needle Sterilization Tub  
SS-3382



Round Endodontic Boxes  
complete with lid  
SS-3383 Ø mm. 94 - h. mm. 70



Endodontic Box  
SS-3384

# HOLLOWARE INSTRUMENTS



**SS-3385**  
100 x 180 x 11mm  
Mini size



**SS-3386**  
100 x 180 x 11mm  
Mini size



**SS-3387**  
100 x 180 x 11mm  
Mini size



**SS-3388**  
100 x 180 x 11mm  
Mini size



**SS-3389**  
100 x 180 x 11mm  
Mini size



Lid  
Coperchio

**SS-3390**  
103 x 182 x 10mm  
Mini size



**SS-3391**  
Silver



**SS-3392** Blue



**SS-3393** Red



**SS-3394** Blue



**SS-3395** Red



**SS-3396**  
Silver



**SS-3397**  
Green



**SS-3399**  
Blue



**SS-3398**  
Golden



**SS-3400**  
Red



**SS-3401**  
Silver



**SS-3402**  
Midi  
125 x 105 x 54mm



**SS-3403**  
Maxi  
204 x 105 x 54mm

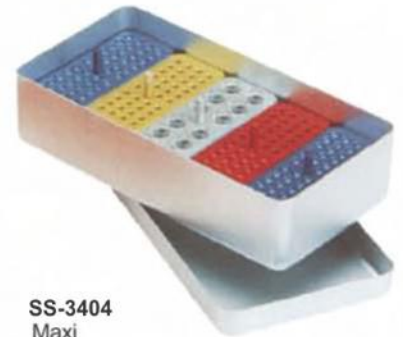

**SS-3404**  
Maxi  
204 x 105 x 54mm





### Round Sterilizer Drum

SS-3405	mm. Ø 80 x 80 H
SS-3406	mm. Ø 125 x 80 H
SS-3407	mm. Ø 125 x 100 H
SS-3408	mm. Ø 125 x 125 H
SS-3409	mm. Ø 150 x 80 H
SS-3410	mm. Ø 150 x 100 H
SS-3411	mm. Ø 150 x 130 H
SS-3412	mm. Ø 150 x 150 H
SS-3413	mm. Ø 150 x 190 H
SS-3414	mm. Ø 190 x 125 H
SS-3415	mm. Ø 190 x 145 H
SS-3416	mm. Ø 190 x 165 H
SS-3417	mm. Ø 190 x 190 H
SS-3418	mm. Ø 190 x 240 H
SS-3419	mm. Ø 190 x 290 H
SS-3420	mm. Ø 240 x 120 H
SS-3421	mm. Ø 240 x 145 H
SS-3422	mm. Ø 240 x 165 H
SS-3423	mm. Ø 240 x 190 H
SS-3424	mm. Ø 240 x 240 H
SS-3425	mm. Ø 240 x 290 H
SS-3426	mm. Ø 240 x 340 H
SS-3427	mm. Ø 240 x 390 H
SS-3428	mm. Ø 290 x 145 H
SS-3429	mm. Ø 290 x 165 H
SS-3430	mm. Ø 290 x 190 H
SS-3431	mm. Ø 290 x 240 H
SS-3432	mm. Ø 290 x 290 H
SS-3433	mm. Ø 290 x 340 H
SS-3434	mm. Ø 290 x 390 H
SS-3435	mm. Ø 340 x 145 H
SS-3436	mm. Ø 340 x 165 H
SS-3437	mm. Ø 340 x 190 H
SS-3438	mm. Ø 340 x 240 H
SS-3439	mm. Ø 340 x 290 H
SS-3440	mm. Ø 340 x 340 H
SS-3441	mm. Ø 340 x 390 H
SS-3442	mm. Ø 390 x 140 H
SS-3443	mm. Ø 390 x 165 H
SS-3444	mm. Ø 390 x 190 H
SS-3445	mm. Ø 390 x 240 H
SS-3446	mm. Ø 390 x 290 H
SS-3447	mm. Ø 390 x 340 H
SS-3448	mm. Ø 390 x 390 H
SS-3449	mm. Ø 390 x 490 H



### Round Sterilizer Drums "Filter"

SS-3450	mm. Ø 80 x 80 H
SS-3451	mm. Ø 125 x 80 H
SS-3452	mm. Ø 125 x 100 H
SS-3453	mm. Ø 125 x 125 H
SS-3454	mm. Ø 150 x 100 H
SS-3455	mm. Ø 150 x 130 H
SS-3456	mm. Ø 150 x 150 H
SS-3457	mm. Ø 150 x 190 H
SS-3458	mm. Ø 190 x 145 H
SS-3459	mm. Ø 190 x 165 H
SS-3460	mm. Ø 190 x 190 H
SS-3461	mm. Ø 190 x 240 H
SS-3462	mm. Ø 240 x 145 H
SS-3463	mm. Ø 240 x 165 H
SS-3464	mm. Ø 240 x 190 H
SS-3465	mm. Ø 240 x 240 H
SS-3466	mm. Ø 240 x 290 H
SS-3467	mm. Ø 240 x 340 H
SS-3468	mm. Ø 240 x 390 H
SS-3469	mm. Ø 290 x 145 H
SS-3470	mm. Ø 290 x 165 H
SS-3471	mm. Ø 290 x 190 H
SS-3472	mm. Ø 290 x 240 H
SS-3473	mm. Ø 290 x 290 H
SS-3474	mm. Ø 290 x 340 H
SS-3475	mm. Ø 290 x 390 H
SS-3476	mm. Ø 340 x 145 H
SS-3477	mm. Ø 340 x 165 H
SS-3478	mm. Ø 340 x 190 H
SS-3479	mm. Ø 340 x 240 H
SS-3480	mm. Ø 340 x 290 H
SS-3481	mm. Ø 390 x 140 H
SS-3482	mm. Ø 390 x 165 H
SS-3483	mm. Ø 390 x 190 H
SS-3484	mm. Ø 390 x 240 H
SS-3485	mm. Ø 390 x 290 H
SS-3486	mm. Ø 390 x 340 H
SS-3487	mm. Ø 390 x 490 H



### Round Bowls With Cover

SS-3488	Ø 40 mm ml.30
SS-3489	Ø 60 mm ml.50
SS-3490	Ø 80 mm ml.150
SS-3491	Ø 100 mm ml.250
SS-3492	Ø 120 mm ml.450
SS-3493	Ø 150 mm ml.750
SS-3494	Ø 180 mm ml.1500
SS-3495	Ø 200 mm ml.2100
SS-3496	Ø 250 mm ml.3500

### Round Bowls With Out Cover

SS-3497	Ø 40 mm ml.30
SS-3498	Ø 60 mm ml.50
SS-3499	Ø 80 mm ml.150
SS-3500	Ø 100 mm ml.250
SS-3501	Ø 120 mm ml.450
SS-3502	Ø 150 mm ml.750
SS-3503	Ø 180 mm ml.1500
SS-3504	Ø 200 mm ml.2100
SS-3505	Ø 250 mm ml.3500

# HOLLOWARE INSTRUMENTS

## INSTRUMENTS MANAGEMENT SYSTEM

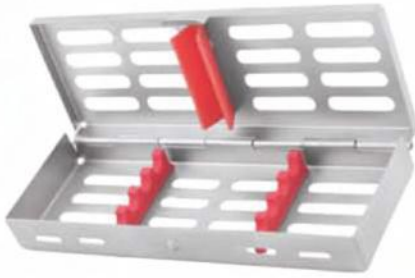

Cassette For 4 Instruments  
SS-3506



Cassette For 5 Instruments  
SS-3507

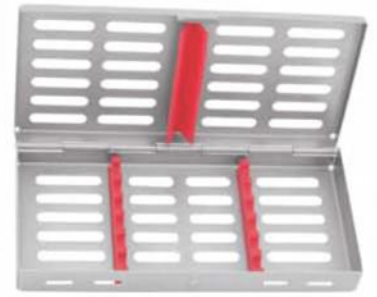

Cassette For 6 Instruments  
SS-3508



Cassette For 7 Instruments  
SS-3509

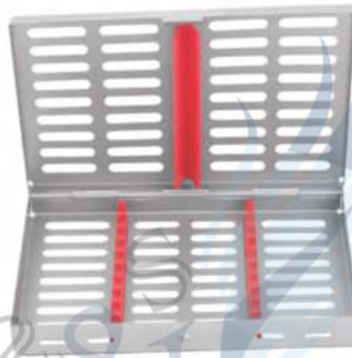

Cassette For 10 Instruments  
SS-3510



Cassette For 20 Instruments  
SS-3511



Cassette For Extraction Forceps  
SS-3512

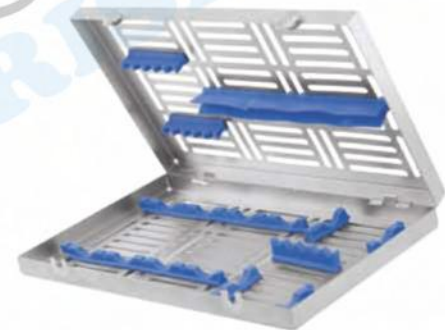

Cassette For Root Elevator  
SS-3513



SS-3514  
Cassette Tray  
15 Pcs



SS-3515  
Cassette Tray  
15 Pcs



## HOLLOWARE INSTRUMENTS

### STERILIZING MESH TRAY

Different sizes & dimensions are available at buyer's demand



**MESH TRAYS**  
SS-3516  
Different sizes & dimensions are available at buyer's demand

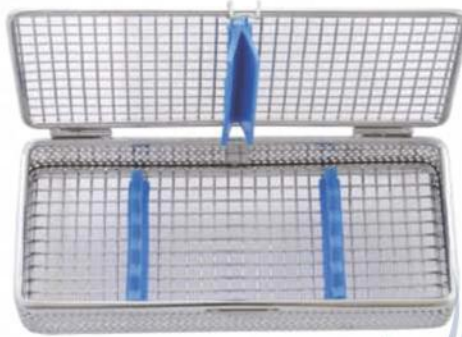

**MESH TRAYS**  
SS-3517  
05 Pcs



**MESH TRAYS**  
SS-3518  
07 Pcs



**MESH TRAYS**  
SS-3519  
10 Pcs



**MESH TRAYS**  
SS-3520  
20 Pcs



**SS-3521**  
Mesh Cassettes  
5 Pieces, 7 Pieces, 10 Pieces,  
15 Pieces & 20 Pieces



**MESH TRAY**  
SS-3522 240x130x50mm  
SS-3523 240x130x60mm  
SS-3524 240x250x50mm  
SS-3525 240x250x60mm  
SS-3526 480x250x50mm  
SS-3527 480x250x60mm  
SS-3528 480x250x70mm



**MESH TRAY**  
SS-3529 240x250x 50mm  
SS-3530 240x250x 60mm  
SS-3531 240x250x 70mm  
SS-3532 480x250x 50mm  
SS-3533 480x250x 60mm  
SS-3534 480x250x 70mm  
SS-3535 480x250x100mm



**MESH TRAY**  
SS-3536 240x250x50mm  
SS-3537 240x250x60mm  
SS-3538 240x250x70mm  
SS-3539 280x250x50mm  
SS-3540 280x250x60mm



**MESH TRAY**  
SS-3541 280x250x 70mm  
SS-3542 280x250x100mm  
SS-3543 280x250x 50mm  
SS-3544 280x280x 60mm  
SS-3545 280x280x 70mm  
SS-3546 300x280x 60mm

# HOLLOWARE INSTRUMENTS



**SS-3547**  
18×7×3.5cm  
5 Instruments Cassette  
Detachable Lids  
+  
5 Instruments Cassette Hinged  
Lids with button Lock



**SS-3548**  
29×18.5×3.5cm  
20 Instruments Cassette Hinged  
Lids with surgical kit fitting,  
button lock



**Instruments Cassette**  
**SS-3549** 5 Pieces Cassette  
**SS-3550** 7 Pieces Cassette  
**SS-3551** 10 Pieces Cassette



**SS-3552**  
18×11×3.5cm  
Extra large cassette for 6  
Instruments, with compartment  
for small parts hinged lids



**SS-3553**  
29×18.5×3.5cm  
20 Instruments Cassette  
Detachable Lids  
+  
20 Instruments Cassette Hinged  
Lids with button Lock

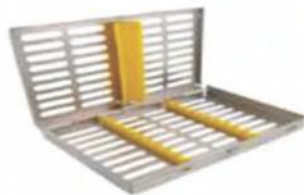

**SS-3554**  
10×13×2.2cm  
10 Instruments Cassette Hinged  
Lids, Click Lock Available in 2  
designs

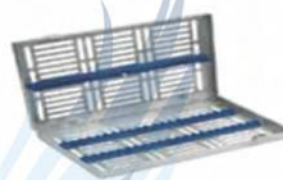

**SS-3555**  
29×18.5×3.5cm  
20 Instruments Cassette Detachable  
Lids with elevator fitting  
+  
20 Instruments Cassette Hinged  
Lids with elevator fitting , button lock

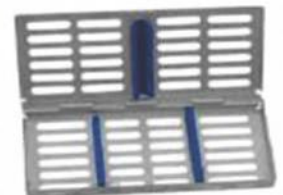

**SS-3556**  
18×9×2.2cm  
7 Instruments Cassette Hinged  
Lids, Click Lock, Available in 2  
designs



**SS-3557**  
21×14×3.5cm  
15 Instruments cassette,  
Detachable lids, button lock



**SS-3558**  
21×14×3.5cm  
15 Instruments cassette,  
detachable lids, button  
lock, with fitting of micro  
surgery kit



**SS-3559**  
21×14×4.5cm  
8 pcs luxator/elevator  
cassette, Detach0  
ablelids, button lock



**SS-3560**  
15×9×5cm  
Box for dental implant tools and  
surgical kits, Capacity:8  
tools, 18 tools, 24 Tools, 58 Tools  
+ removable compartment



**Instruments Tray Perforated**  
**SS-3561** 288 x 187 x 40 mm



**Instruments Tray Perforated Base**  
**SS-3562** 288 x 187 x 40 mm



**Instruments Tray Solid Base**  
**SS-3563** 288 x 187 x 40 mm





SS-3564 Implant Basic Starter Kit 11 instruments with case



SS-3565 Crown Bridge Set Instruments with Case



SS-3566 Bone Curettes Spoon Style set of 4 with Metal Case



SS-3567 Peritome Set of 2 with Blue Nitrate Tips and Metal Case



SS-3568 Root Fragment Removal elevators, Set of 4 with Metal Case



SS-3569 Peritome Set of 3 Gold Handles Serrated Blades with Metal Case



DESCRIPTION	PAGE#
<b>A</b>	
A COSMETIC CONTOURING IMPLANTOLOGY	148
AB1 BOGHOSIAN IMPLANTOLOGY	147
AB2 BOGHOSIAN IMPLANTOLOGY	147
ABDU-RASS EXPLORERS	54
ACUTE IMPLANTOLOGY	161
ADAMS PLIER	133
ADAMS PLIER ROUND BOX	133
ADAMS PLIERS FOR HOOKS AND BENDING	138
ADAMS, SMALL WIRE BENDING AND LOOP FORMING PLIERS	132
ADERER CLAMP THREE JAW WIRE BENDING PLIER	138
ADERER FACEBOW LOOP FORMING PLIERS	134
ADERER LARGE WIRE BENDING AND LOOP FORMING PLIERS	133
ADERER PLIER	134
ADHESIVE REMOVING PLIERS	36,141
ADSON 7X7 CURVED TISSUE FORCEPS	169
ADSON BROWN TWEEZERS	53
ADSON CARBIDE TIPPED TISSUE FORCEPS	169
ADSON NEEDLE HOLDERS	107
ADSON-TC TWEEZERS	53
ADULT PALATAL DENTAL PHOTOGRAPHIC MIRRORS	98
ALLIS HAEMOSTATIC FORCEPS	110
ALLIS-BABY HAEMOSTATIC FORCEPS	110
ALL-PURPOSE PLIERS	109
ALLUMINIUM CALIPER	127
ALM RETRACTOR	102
AMALGAM CARRIERS	117
AMALGAM INSTRUMENTS	116,117
AMALGAM WELL	115,117
ANATOMIC HANDLE EXPLORERS	54
ANDREWS FILLING INSTRUMENTS	87
ANGLE HOW PLIER	139
ANGLED DIRECT BOND BRACKET REMOVER TC	139
ANGLED EXTRACTING FORCEPS FOR UPPER ROOTS	03
ANGLED UTILITY PLIERS	136
ANISWORTH RUBBER DAM CLAMPS FORCEPS	111
ANTERIOR	58
APEX FORCEPS LOWER ROOT DEEP ROOT PICK	06
APEX FORCEPS LOWER UNIVERSAL DEEP ROOT PICK	05
APEXO ROOT ELEVATORS	29
APICAL RETENTION FORCEPS	23
APICAL ROOT ELEVATORS	31,33
ARCH BENDING PLIERS	38,143
ARROW CLASP FORMING PLIERS	139
ARTICULATORS	97
ASPIRATING SYRING	27
ATRAUMATIC TWEEZERS	52
ATRAUMATIC WITH LOCK TWEEZERS	52
<b>B</b>	
BABY TOOTH EXTRACTION FORCEPS SET OF 7 PIECES	08
BACK ACTION FILLING INSTRUMENTS	88
BACKHAUS HAEMOSTATIC FORCEPS	110
BACKHAUS TOWEL CLAMPS	110
BACOLITE HANDLE WAX KNIVES	96
BALL BURNISHERS	71
BALL FILLING INSTRUMENTS	93
BALL SOCKET NOT-PERFORATING AND NOT-DAMAGING	110
BALLACORN FILLING INSTRUMENTS	88
BAND REMOVING PLIERS	32,136
BAND SEATER AUTO CLEAVABLE	129
BAND SEATER AUTO CLEAVABLE ROUND SHAPE	129
BAND SEATER AUTO CLEAVABLE SQUARE SHAPE	129
BAND SEATER AUTO CLEAVABLE TRIANGLE SHAPE	129
BAND SEATING & REMOVING INSTRUMENTS	129
BAND SEATING & REMOVING SILICON GRIP	129
BAND SEATING PLIERS	141
BANDS & CROWNS PLIER	134
BARRAQUER T.C NEEDLE HOLDERS	109
BASINS FOR BONE	174
BAUMGARTNER NEEDLE HOLDERS	06,107
BAYONET ROOTS ELEVATOR SET	36
BEAVERTAIL FILLING INSTRUMENTS	88
BEEBEE GUM SCISSORS	106
BEERENDONK CALIPER	127
BEIN ROOT ELEVATORS	29,40
BENDING PLIER	138
BESEK COMPOSITE INSTRUMENTS	72
BESEK COMPOSITE MODELLING INSTRUMENTS	85
BESEK COMPOSITE PLUGGERS INSTRUMENTS	82
BESEK PLUGGERS	76
BEYER BONE ROUNDER	25
BINANGLE SCALER	67
BIRD BEAK PLIER	38,141
BIRD BEAK PLIER FOR BENDING	138
BIRD BEAK PLIER STANDARD	133
BIRD BEAK WIRE BENDING & CUTTING PLIERS	134
BIRD BEAK WIRE BENDING PLIER	133
BISHOP RETRACTORS	101
BLACK FILLING INSTRUMENTS	80,87
BLACK SCALER	66
BLACK TITANIUM COLOUR COATED INSTRUMENTS	147,148,149
BLADE AND PUSHER	166
BLUE TITANIUM COATED BONE GRAFTING INSTRUMENTS	59,187
SET OF 7 PCS WITH CASSETTE	159
BLUMENTHAL BONE ROUNDER	25
BOLEY GAUGE	127
BONE BRACKET GAUGE	125
BONE CARRIER TITANIUM	165
BONE CRUSHER	174
BONE CRUSHER TITANIUM METAL CUTTER	174
BONE EXPANDER KIT	176
BONE EXPANDER SCREW & SURGICAL KITS	176
BONE FILES	119
BONE GRAFT	159
BONE GRAFT IMPLANTOLOGY	156
BONE GRAFT PACKER	164
BONE GRAFT/CARRIER TITANIUM	167
BONE GRAFTING INSTRUMENTS COMPACTOR /TAMPERS	166
BONE INJECTORS, COLLECTORS & SUCTION TUBE	175
BONE MILL	174
BONE ROUNDER	25
BONE SCRAPER	173
BONE SCRAPER STRAIGHT & CURVED	173
BONE SPOON/PACKER	166

DESCRIPTION	PAGE#
BONE THICKNESS GAUGE	146
BONE UNIVERSAL KIT	176
BONE WELL	174
BOX FOR DENTAL IMPLANT TOOLS AND SURGICAL KITS	191
BOX JOINT PLIERS	132,133,134
BRACKET HOLDER TWEEZERS	128
BRACKET PLACER TWEEZERS	128
BRACKET PLACING TWEEZERS	128
BRACKET REMOVING PLIER CURVED	132
BRACKET REMOVING PLIER ROUND BOX	132
BRACKET REMOVING PLIERS ANGLED	136
BRACKET REMOVING PLIERS STRAIGHT	136
BRACKET REMOVING PLIERS WITH PLASTIC TIP	136
BRACKET TWEEZERS SLOT ALIGNER	128
BREWER RUBBER DAM CLAMPS FORCEPS	111
BRUENINGS RETRACTORS	101
BUCCAL AND LINGUAL/PALATAL SCALER	61
BUCCAL DENTAL PHOTOGRAPHIC MIRRORS	98
BUCCAL SURFACES SCALER	61
BUCCAL-SMALL DENTAL PHOTOGRAPHIC MIRRORS	98
BURNISHER FILLING INSTRUMENTS	78,88
BURNISHERS	149
BURNISHERS CONSERVATIVE TREATMENT	68,71
BUSER PERIODONTAL INSTRUMENTS	121
<b>C</b>	
COSMETIC CONTOURING IMPLANTOLOGY	148
CARBIDE DIAMOND COATED POINT	24
CARRY FORCEPS	170
CARVER COMPOSITE MODELLING INSTRUMENTS	85
CARVERS INSTRUMENTS	89,90
CARVERS INSTRUMENTS CASSETTE FOR 5 INSTRUMENTS	90
CASSETTE FOR INSTRUMENTS	162
CASTROVIEJO CALIPERS	126
CASTROVIEJO GUM SCISSORS	105
CASTROVIEJO MICRO SCISSORS	108
CASTROVIEJO NEEDLE HOLDERS	107,109
CATHETERS TRAY WITH LID BOX WITH FILTER	184
CATRIDGE SYRING	27
CEMENT SPATULAS	95
CERI SAW	124
CHEEK RETAINER	101
CHILD PALATAL DENTAL PHOTOGRAPHIC MIRRORS	98
CHIP BLOWER	116
CHISELS, BONE FILES & SPOONE CURETTE	118
CHISELS SCALER	65,67
CHOMPRET ROOT ELEVATOR	42
CINCH BACK / TIE BACK DISTAL END BENDING PLIERS	137
CLAW-LIFT ROOTS ELEVATOR	37
COARSE SUCTION TUBES	178
COBRA IMPLANTOLOGY	156
COHEN UNIVERSAL EXTRACTING FORCEPS (AMERICAN PATTERN)	17
COLLEGE FORCEPS	51
COLLEGE TWEezer	53
COLLEGE WITH LOCK TWEEZERS	52
COLLINS TONGUE FORCEPS	110
COLUMBIA RETRACTOR	99
COMBINATION RETRACTORS	101
COMELLAS FORCEPS ANATOMICAL HANDLE	26
COMPASSO DE WILLIS	127
COMPOSITE BALL PLUGGERS	76
COMPOSITE FILLING INSTRUMENTS	92,93
COMPOSITE FILLING INSTRUMENTS SET OF 6 PCS	153
COMPOSITE GOLD TIP INSTRUMENTS	93
COMPOSITE INSTRUMENTS	72,73
COMPOSITE INSTRUMENTS BLUE TITANIUM WITH CASSETTES	89
COMPOSITE INSTRUMENTS TITANIUM BLUE ENDOODONTIC	89
COMPOSITE MODELLING INSTRUMENTS	85
COMPOSITE PLUGGERS INSTRUMENTS	82,83
COMPOSITE/PLASTIC FILLING INSTRUMENTS	87
CONDENSER IMPLANTOLOGY	150,161
CONE-SOCKET MOUTH MIRRORS	49
CONE-SOCKET FRONT SURFACE MOUTH MIRRORS	49
CONE-SOCKET MIRROR HANDLES FOR MOUTH MIRRORS	50
CONE-SOCKET PLAIN MOUTH MIRRORS	49
CONE-SOCKET RHODIUM MOUTH MIRRORS	49
CONE-SOCKET SOLID HANDLES FOR MOUTH MIRRORS	50
CONE-SOCKET SOLID OCTAGONAL HANDLES FOR MOUTH MIRRORS	50
CONTOURING PLIER	134,138
COPERCHIO HOLLOWWARE INSTRUMENTS	167
CORROSION-RESISTANT	145
COTTON HOLDER	186
COTTON HOLDING JAR	186
COTTON WOOL DISPENSER ACC. TO METHOT	186
COUPLAND ROOT ELEVATORS	34
CRANE KAPLAN TWEEZERS	53
CRILE-WOOD NEEDLE HOLDERS	106,107
CROWN REMOVER	114
CROWN SPREADERS	114
CRUCIBLE TONGS	124
CRUYER EXTRACTING FORCEPS (AMERICAN PATTERN)	12,13,19,20
CRUYER ROOT ELEVATORS	32
CUTTER	139,142
CUTTER, UTILITY PLIERS & WIRE FORMING PLIERS	141
<b>D</b>	
DEAN GUM SCISSORS	105
DEBAKEY ATRAUMATIC TISSUE FORCEPS	169
DELUX BOLEY GAUGE	127
DELUXE BRACKET HOLDER	128
DELUXE BRACKET HOLDER TWEEZERS	128
DENHARD RETRACTORS - MOUTH GAGS	100
DENTAL PHOTOGRAPHIC MIRRORS	98
DENTAL SYRINGES	27
DENTAURUM CALIPER	127
DERF NEEDLE HOLDERS	106,107
DETAILING STEP PLIER	139
DETAILING STEP PLIERS / BAYONET BENDING PLIERS	137
DIAMOND COATED MARGIN TRIMMERS	65
DIRECT BOND BRACKET HOLDER TWEEZERS	128
DIRECT BOND BRACKET HOLDER TWEEZERS, SMALL TIP	128
DIRECT BONDING BRACKET HOLDERS	128
DIRECT BRACKET REMOVER TC	140
DISC SYSTEM DENTAL SYRINGES	27
DISSECTING SET SET OF 11 PCS	94
DISSECTING SET SET OF 9 PCS	94



## DESCRIPTION PAGE#

DISTAL AMALGAM CARRIERS	117
DISTAL BENDER SILICON GRIP	129
DISTAL CUTTER	139
DISTAL END CUTTER	135
DISTAL END CUTTER FLUSH CUT	142
DISTAL END CUTTER, SAFETY HOLD PLIER (IDEAL FOR CUTTING WIRE) TC	140
DISTAL END, WIRE CUTTERS & BRACKET REMOVER PLIERS	140
DISTAL SCALER	61,63
DOUBLE ENDED CEMENT SPATULA	131
DOUBLE ROUNDED JAW BENDING PLIERS	138
DOUBLE ENDED EXPLORERS	54
DRESSING TWEEZERS	52,53
DYNAMOMETER	146

<b>E</b>	
EASY ACCESS TWEEZES	128
EBNETER SCALER	64
ELASTIC INSTRUMENT SILICON GRIP	129
ELASTIC SEPARATING PLIER	140
ELASTIC SEPARATING PLIER ROUND HANDLE	140
ELASTOMERIC LIGATURE PLACING FORCEPS WITH GROOVE FALCON	140
ELEVATORS SET OF 8 PCS	46
ELEVATORS SET OF 8 PCS	46
ELLIOT SIQVELAND RETAINERS	115
ENDO FINGER RULER SPAN MEASURE SCALE	125
ENDODONTIC BOX	186
ENDODONTIC EXPLORER	154
ENDODONTICS INSTRUMENTS	58
ERGO GRIP RETRACTOR	101
EURO BREECH LOADING/DENTAL SYRINGES	27
EXAVATORS EXPLORERS	51
EXCAVATOR INSTRUMENTS	74
EXCAVATORS	86
EXECT BRACKET HOLDER TWEEZERS	128
EXPLORERS	51,54,55,56
EXTRACTING FORCEPS (AMERICAN PATTERN)	126to24
EXTRACTING FORCEPS (ENGLISH PATTERN)	01to07,26

EXTRACTING FORCEPS (ENGLISH PATTERN) SET OF 10 PIECES	07
EXTRACTING FORCEPS	08
EXTRACTING FORCEPS AMERICAN ADULT SET OF 10 PCS	28
EXTRACTING FORCEPS AMERICAN ADULT SET OF 8 PCS	28
EXTRACTING FORCEPS CHILDREN PATTERN SET OF 10 PCS	28
EXTRACTING FORCEPS ENGLISH ADULT ADULT SET OF 10 PCS	28
EXTRACTING FORCEPS PEDO SET OF 7 PCS	28
EXTRACTING FORCEPS SET	28
EXTRACTING FORCEPS SET OF 10 PIECES	28
EXTRACTING FORCEPS SET OF 10 PIECES	28
EXTRACTING FORCEPS SET OF 13 PIECES	28
EXTRA-FLEX IMPLANTOLOGY	147

<b>F</b>	
FALCON BEAK CONTOURING PLIERS	133,138
FARABEUF RETRACTORS SET OF 2 PICES)	103
FELDMAN RETRACTOR	103
FILLING INSTRUMENTS (GOLD POINTED)	91
FILLING INSTRUMENTS	87,88,91,93
FILLING INSTRUMENTS CONSERVATIVE TREATMENT	69,70,75,78,79,81,84
FIRST AID EXAMINATION SET OF 3 PICES	51
FLEXIBLE PERITOME	163
FLEXI-THIN IMPLANTOLOGY	147
FLOHR ROOT ELEVATORS	79,33
FLUSH-CUT DISTAL AND CUTTING PLIERS	133
FLUSH-CUT DISTAL END CUTTER	135
FOERSTER DRESSING FORCEPS	110
FRAZIER SUCTION TUBES WITH FILTER	178
FREEDMAN "DUCKHEAD"	149
FREEDMAN BURNISHERS	149
FREEDMAN LARGE CONTACT FORMING	149
FREEDMAN SMALL CONTACT FORMING	149
FREER PERIODONTAL INSTRUMENTS	121
FREER PERIOSTEEL ELEVATORS	120
FRET SAW	124
FRIEDMAN BONE ROUNDER	25
FRIEDMANN ROOT ELEVATOR	36
FRIEDMANNRICHARD PERIODONTAL INSTRUMENTS	122
FUZZI COMPOSITE MODELLING INSTRUMENTS	85

<b>G</b>	
GERALD TWEEZERS	52
GILLES TWEEZERS	52
GILLIES NEEDLE HOLDER WITH SCISSORS	107
GLOVES BOX	184
GOLD COLOR SET DENTAL ORAL IMPLANTOLOGY SINUS SET OF 10 PCS WITH CASSETTE	156
GOLD MILL (LARGE)	174
GOLD MILL (SMALL)	174
GOLDMAN FOX SUPER CUT SCISSORS	108
GOLDMAN FOX EXPLORERS	55
GOLDMAN FOX SCISSORS	108
GOLDMAN-FOX GUM SCISSORS	104,105
GOLDMAN-FOX PERIODONTAL INSTRUMENTS	121
GOLDMANN-FOX SCALER	64
GRACEY AFTER FIVE	67
GRACEY CURETTES SCALER	61
GRACEY CURETTES	59,63
GRACEY MINI FIVE	60
GRACEY SCALER	61
GRAFT MATERIAL SPOON CONCAVE TIP FOR LARGER GRAFTS	165
GRAFT PACKER	166
GRAFT PACKER, CONCAVE	166
GRIPPER CARBIDE TIPPED TISSUE FORCEPS TC	169
GRITMAN CEMENT SPATULAS	95
GROSS MAIER DRESSING FORCEPS	110
GULDENER SCALER	64
GUM SCISSORS	104to108

<b>H</b>	
HAEMOSTATIC FORCEPS & TOWEL CLAMPS	110
HALSEY NEEDLE HOLDERS	106,107
HALSTEAD MOSQUITO HAEMOSTATIC FORCEPS	110
HALSTEAD MOSQUITO NEEDLE HOLDERS	107
HALTEPINZETTE WITH LOCK TWEEZERS	170

## DESCRIPTION PAGE#

HAMMER HEAD DISTAL END BENDING PLIERS	137
HAMMER WITH WOODEN HANDLE	124
HANDLE ROUND HANDLES FOR MOUTH MIRRORS	50
HANDLES FOR MOUTH MIRRORS	50
HARD WIRE CUTTER	142
HARD WIRE CUTTER STRAIGHT	142
HARD WIRE CUTTER, 15° ANGLED	135
HARD WIRE CUTTER, 16° ANGLED NON-AUTOCALAVABLE	135
HARD WIRE CUTTER, STRAIGHT	140
HARD WIRE CUTTERS	140
HARRIS EXTRACTING FORCEPS (AMERICAN PATTERN)	13,18
HARTMANN (BABY MOSQUITO) NEEDLE HOLDERS	107
HEAT CARRIERS	57
HEBER BAYONET ROOTS ELEVATOR	40
HEBER ROOTS ELEVATOR	40
HEIDBRINK ROOT APPEX ELEVATOR	44
HEIDBRINK ROOT ELEVATORS	33,43
HEIDBRINK ROOTS ELEVATOR WARWICK-JAMES	44
HEIDEMANN FILLING INSTRUMENTS	93
HEIDEMANN SPATULAS	73
HEIGHT GAUGE 0.18 STAINLESS STEEL	125
HEIGHT GAUGE ALUMINIUM	125
HEMINGWAY TWEEZERS	53
HEX TORQUE WRENCH UNIVERSAL	177
HEXAGONAL HANDLES FOR MOUTH MIRRORS	50
HIRSCHFELD PERIODONTAL INSTRUMENTS	122
HIRT COMPOSITE MODELLING INSTRUMENTS	85
HIRT COMPOSITE PLUGGERS INSTRUMENTS	83
HIRT SCALER	66
HMG HEISTER	99
HOLLENBACK FILLING INSTRUMENTS	80,87
HOLLOW CHOP CONTOURING PLIERS	143
HOLLOW HANDLES FOR MOUTH MIRRORS	50
HOLLOW MIRROR HANDLES FOR MOUTH MIRRORS	50
HOLLOWWARE INSTRUMENTS	183,184,186,187,190,191
HOLZ SCALER	65
HOOK CRIMPING PLIER ANGLED STRAIGHT TC	140
HOOK KNIVES	96
HOPSON FILLING INSTRUMENTS	78
HOW PLIER	132
HOW PLIER CURVED	132
HOW PLIERS OFFSET	141
HOW STRAIGHT UTILITY PLIERS	141
HOWARD PERIOSTEEL ELEVATORS	120
HULL EXTRACTING FORCEPS (AMERICAN PATTERN)	19
HYLIN CEMENT SPATULAS	95
HYLIN ROOTS ELEVATOR	39

<b>I</b>	
IMPLANT GAGES	145
IMPLANT SINUS LIFT INSTRUMENTS	161,162
IMPLANTOLOGY	145to178
IMPLANTOLOGY 9 PCS OF SET	161
IMPLANTOLOGY SET OF 2 COMPOSITE BLUE TIP INSTRUMENTS	154
IMPLANTOLOGY SET OF 3 COMPOSITE BLUE TIP INSTRUMENTS	154
IMPLANTOLOGY SET OF 4 COMPOSITE BLUE TIP INSTRUMENTS	154
IMPLANTOLOGY SET OF 5 COMPOSITE GOLD TIP INSTRUMENTS	154
IMPRESSION TRAYS	179to182
IMPRESSION TRAYS PERFORATED FULL DENTURE SET OF 8 PCS	181
IMPRESSION TRAYS PERFORATED WITHOUT RIM LOCK	182
IMPRESSION TRAYS SOLID FULL DENTURE SET OF 06 PCS	181
IMPRESSION TRAYS SOLID FULL DENTURE SET OF 8 PCS	182
IMPRESSION TRAYS SOLID WITH RIM LOCK	182
IMPRESSION TRAYS SOLID WITH RIM LOCK SET OF 06 PCS	180
IMPRESSION TRAYS SOLID WITH RIM LOCK SET OF 08 PCS	180
IMPRESSION TRAYS SOLID WITH RIM LOCK SET OF 10 PCS	180
INSTRUMENTS BOX	184
INSTRUMENTS BOX PERFORATED	184
INSTRUMENTS BOX WITH HOOKS	184
INSTRUMENTS BOX WITH LID	184
INSTRUMENTS CASSETTE 10 HINGED	191
INSTRUMENTS CASSETTE 10 PIECES CASSETTE	191
INSTRUMENTS CASSETTE 15, SURGERY KIT	191
INSTRUMENTS CASSETTE	191
INSTRUMENTS CASSETTE 20 DETACHABLE	191
INSTRUMENTS CASSETTE 20 DETACHABLE LIDS	191
INSTRUMENTS CASSETTE 20 HINGED	191
INSTRUMENTS CASSETTE 5 DETACHABLE LIDS	191
INSTRUMENTS CASSETTE 5 HINGED LIDS WITH BUTTON LOCK	191
INSTRUMENTS CASSETTE 5 PIECES CASSETTE	191
INSTRUMENTS CASSETTE 7 HINGED	191
INSTRUMENTS CASSETTE 7 PIECES CASSETTE	191
INSTRUMENTS TRAY PERFORATED	183,181
INSTRUMENTS TRAY PERFORATED BASE	191
INSTRUMENTS TRAY SOLID BASE	191
INSTRUMENTS TRAYS	183
INSTRUMENTS TRAYS WITH COVER	184
INSTRUMENTS TRAYS WITH LID	183
INSTRUMENTS TRAYS WITHOUT COVER	184
INTRALIGAMENTAL ANESTHESIA SYRINGE	27
IRIS GUM SCISSORS	104
IRIS SUPER CUT SCISSORS	108
IRIS GUM SCISSORS	104,105,108
IVORY SIQVELAND RETAINERS	115
IVORY LIGHT WEIGHT RUBBER DAM CLAMPS FORCEPS	111
IVORY MATRIX RETAINERS	115
IVORY RETRACTORS	101
IVORY RUBBER DAM CLAMPS FORCEPS	111
IWANSON SPRING CALIPER FOR METAL AND PORCELAIN	126
IWANSON SPRING CALIPER FOR WAX	126

<b>J</b>	
JAUQUETTE SCALER	63
JARABAK PILERS	143
JECT ULTIMA DENTAL SYRINGES	27
JENNINGS RETRACTORS - MOUTH GAGS	100
JOHNSON CONTOURING PLIERS	133
JOHNSON PLIERS FOR CROWN BAND CONTOURING	138
JONES TOWEL CLAMPS	110
JOSEPH GUM SCISSORS	105

<b>K</b>	
KALT NEEDLE HOLDERS TC	109
KELLS EXTRACTING FORCEPS (AMERICAN PATTERN)	15



DESCRIPTION	PAGE#
KELLY GUM SCISSORS	104,105
KELLY HAEMOSTATIC FORCEPS	110
KELLY-RANKIN HAEMOSTATIC FORCEPS	110
KEY RINGS	94
KEYS FOR IMPLANT SCREW	177
KILNER (RAGNELL) GUM SCISSORS	105
KIRKLAND SCALER	64
KLEIN EXTRACTING FORCEPS	28
KLEINERT-KUTZ BONE ROUNGER	25
KOPP ROOTS ELEVATOR	39
KRAMER NEVINS SINUS LIFT	162
KRAMER-NEVINS PERIODONTAL INSTRUMENTS	121
KRARNER-NEVINS BONE CHISEL	119
KUEHNE TWEEZERS	170
<b>L</b>	
LA GRANGE NEEDLE HOLDERS	109
LA GRANGE GUM SCISSORS	104,105
LADMORE FILLING INSTRUMENTS	88
LADMORE IMPLANTOLOGY	149
LAGRANGE SCISSORS	108
LAGRANGE SUPER CUT SCISSORS	108
LANGENBECK RETRACTORS	103
LANGER SCALER	63
LAP & L-KEY JOINT PLIERS	139
LARGE FLUCH-CUT DISTAL AND CUTTING PLIERS	133
LAXUTOR ROOT ELEVATORS	30,31
LAXUTOR ROOT ELEVATORS SET OF 9 PCS	38
LE CRON CEMENT SPATULAS	95
LECLUSE BAYONET ROOT ELEVATOR	41
LESSMANN WAX KNIVES	96
LICHTENBERG-RYDER TC NEEDLE HOLDERS	109
LIGATURE FORMING PLIERS	134
LIGATURE INSTRUMENT SILICON GRIP	129
LIGHT WORE BIRD BEAK PLIERS WITH GROOVE	143
LINDO LEVIAN ROOT ELEVATORS	35
LINGUAL / PALATAL ARCH FORMING PLIERS	134
LINGUAL ARCH FORMING PLIERS	143
LINGUAL DENTAL PHOTOGRAPHIC MIRRORS	98
LINGUAL/PALATAL SURFACES SCALER	61
LINGUAL-LARGE DENTAL PHOTOGRAPHIC MIRRORS	98
LIP & CHEEK RETRACTOR	100
L-KEY JOINT PLIERS	139to136
LOCKLIN GUM SCISSORS	105
LONDON COLLEGE TWEEZERS	52
LONDON HOSPITAL	34
LONG IMPLANT DRILLS	176
LOOP FORMING IN FOUR LENGTH	138
LORNAHAEMOSTATIC FORCEPS	110
LUCAS IMPLANTOLOGY	168
LUER BONE ROUNGER	25
LUKS	58
LUXATING ELEVATOR / PERIOTOME	36
LUXATING ELEVATOR WITH PERIOTOME TIP	36
LUXATOR ROOT ELEVATORS	29
LUXATOR/ELEVATOR 8 PCS	191
LUXATORS SET OF 7 PCS	46
LUXATORS SET OF 7 PCS	46
LUXATORS SET OF 8 PCS	46
LUXIER ROOTS ELEVATOR	40
LUXIVATORS CURVED ATRAUMATIC LUXATION OF THE TOOTH	48
LUXIVATORS STRAIGHT ATRAUMATIC LUXATION OF THE TOOTH	48
<b>M</b>	
MAGNIFYING MOUTH MIRRORS	49
MALLET IMPLANTOLOGY	174
MALLETS - PLASTER SHEARS - SAWS & BLADES	124
MANUAL ASPIRATING SYRINGE	27
MANUAL CROWN REMOVERS	114
MARGIN TRIMMERS	66
MARGINAL RIDGE & EMBRASURE SHAPING INSTRUMENT	148
MARKLEY FILLING INSTRUMENTS	93
MARQUETTE CONDENSER	87
MARQUETTE PLUGGERS	87
MARYAM TWEEZERS	53
MATHIEU NEEDLE HOLDERS	107
MATRIX RETAINERS	115
MAXI HOLLOWARE INSTRUMENTS	187
MAYO GUM SCISSORS	104
MAYO NEEDLE HOLDERS	106
MAYO TRAY PERFORATED	183
MAYO-HEGAR NEEDLE HOLDERS	106,107
MCCALL SCALER	63
MEAD BONE ROUNGER	25
MEAD NON AUTO CLAVABLE PLASTIC TIPS	119
MEASURING LOOP	126
MEASURING LOOP CASTROVIEJO	126
MEASURING PROBE	145
MEISSNER EXTRACTING FORCEPS	26
MEMBRANE IMPLANTOLOGY	161
MEMBRANE 3POSITIONING IMPLANTOLOGY	150
MEMBRANE DETACH ELEVATOR	164
MEMBRANE ELEVATOR	164
MEMBRANE TWEEZERS	170
MERIAM TWEEZERS	52
MERRIT B EXPLORERS	55
MERSON BAND PUSHER	129
MESH CASSETTES 5 PIECES, 7 PIECES, 10 PIECES, 15PIECES & 20 PIECES	190
MESH TRAY	190
MESH TRAYS 05 PCS	190
MESH TRAYS 07 PCS	190
MESH TRAYS 10 PCS	190
MESH TRAYS	190
MESH TRAYS 20 PCS	190
MESIAL SCALER	61
METZENBAUM GUM SCISSORS	104,106
MICOR ADSON 1X2 TISSUE FORCEPS	169
MICRO BOLEY GAUGE STRAIGHT	146
MICRO BOLEY GAUGE TWISTED	146
MICRO IRIS GUM SCISSORS	104
MICRO SURGICAL SCALPEL HANDLE TITANIUM	123
MICRO-FRIEDMAN BONE ROUNGER	25
MICRO-MINI PIN & LIGATURE CUTTER	142
MIDDELBORPF RETRACTORS	103
MILLER BONE FILES	119
MILLER ROOT ELEVATORS	37

DESCRIPTION	PAGE#
MILLER IMPLANTOLOGY	168
MILLER ROOT PLANNING FILES	119
MILLER TWEEZERS	53
MINI DISTAL AMALGAM CARRIERS	117
MINI GAUGE	127
MINI LIGATURE CUTTERS	133
MINI PIN & LIGATURE CUTTER	142
MINI PIN & LIGATURE CUTTER TC	139
MINI-LANGENBECK RETRACTORS	102
MINI-SPATEL BURNISHERS	71
MINNESOTA RETRACTORS	101
MIRROR EXPLORERS	51
MIRROR HANDLE STEM WITH RULE HANDLES FOR MOUTH MIRRORS	50
MISCELLANEOUS PRODUCTS	94
MIXING SPATULA WITH SHOVEL	165
MOLT 9 PERIODONTAL INSTRUMENTS	121
MOLT AUTO CLAVABLE PLASTIC TIPS	119
MONARI COMPOSITE MODELLING INSTRUMENTS	85
MORTENSON FILLING INSTRUMENTS	80,87
MOUTH MIRROR EXPLORERS	51
MOUTH MIRRORS	49
MOUTH PROPS	94
MOVEABLE HEIGHT GAUGE	125
MSY CEMENT SPATULAS	95
MUHELMANN SCALER	64,85
MULTIFUNCTIONAL METER	145
MULTI-PURPOSE PLIERS	137
<b>N</b>	
NAKAWANI DENTAL LABORATORY INSTRUMENT	97
NANCE LOOP FORMING PLIERS	132,137
NAPKIN HOLDER WITH METAL CHAIN	94
NAPKIN HOLDER WITH PLASTIC CHAIN	94
NARROW SIOVELAND RETAINERS	115
NEEDLE HOLDERS	106to109
NEEDLE STERILIZATION TUB	186
NEUMANN GUM SCISSORS	105
NEVIUS EXTRACTING FORCEPS (AMERICAN PATTERN)	14,16
NORMAL HANDLE EXPLORERS	54
NOYES GUM SCISSORS	105
<b>O</b>	
OBTUSE IMPLANTOLOGY	161
OCCUSAL ANATOMY INSTRUMENT	148
OHL PERIOSTEEL ELEVATORS	120
OLSEN-HEGAR NEEDLE HOLDER WITH SCISSORS	107
OMEGA LOOP FORMING PLIERS	141
ORBAN SCALER	64
ORTHO BAND PUSHER SCALER	131
ORTHO INSTRUMENT	130
ORTHO LIGATURE DIRECTOR SINGLE ENDED	131
ORTHO LIGHT BAND PUSHER SCALER	129
ORTHO LIGHT DOUBLE ENDED LIGATURE	131
ORTHO LIGHT DOUBLE ENDED LIGATURE DIRECTOR	131
ORTHO LIGHT DOUBLE ENDED LIGATURE DIRECTOR SCALER	129,131
ORTHO LIGHT DOUBLE ENDED LIGATURE SCALER	131
ORTHO LIGHT LIGATURE DIRECTOR DOUBLE ENDED	131
ORTHO LIGHT SCALER	130
ORTHO LIGHT SCALER DOUBLE ENDED	130
ORTHO LIGHT SCALER HEAVY	130
ORTHO LIGHT SCALER SINGLE ENDED	131
ORTHO RULER / CONE SOCKET	146
ORTHODONTIC INSTRUMENTS	129to131
ORTHODONTICS PLIERS STANDS	144
ORTHOLITE LIGATURE DIRECTOR SCALER	131
OSTEOMETER MEASURING FORCEPS FOR JAW	146
OSTEOTOME CONVEXES / CONCAVE / CONIQUES	171,172
OSTEOTOME CONVEXES / CONCAVE / CONIQUES SET OF 5 PIECES	172
<b>P</b>	
P.K. THOMS WAXING INSTRUMENTS KIT	89
P.K. THOMS WAXING INSTRUMENTS SOLID HANDLE	89
PALATAL-ADULT DENTAL PHOTOGRAPHIC MIRRORS	98
PALATAL-ADULT LARGE DENTAL PHOTOGRAPHIC MIRRORS	98
PALATAL-CHILD DENTAL PHOTOGRAPHIC MIRRORS	98
PALMER RUBBER DAM CLAMPS FORCEPS	111
PARMLY EXTRACTING FORCEPS (AMERICAN PATTERN)	16
PARTSCH PERIOSTEEL ELEVATORS	120
PDL ELEVATORS	47,48
PDL ELEVATORS SET OF 7 PCS	47
PDL ELEVATORS SET OF 7 PCS	47
PDL ELEVATORS SET OF 8 PCS	48
PEDIATRIC TOOTH EXTRACTING FORCEPS SET	48
PEET SPLINTER FORCEPS	109
PERFORATED WITH RIM LOCK SET OF 06 PCS	179
PERFORATED WITH RIM LOCK SET OF 10 PCS	179
PERFORATED WITH RIM LOCK SET OF 8 PCS	179
PERIODONTAL CHISELS	118
PERIODONTAL INSTRUMENTS	120to122
PERIODONTAL KNIVES	64
PERIODONTAL PROBES	58
PERIODONTAL PROBESSPREADERS	57
PERIODONTAL SURGERY	162
PERIOSTEEL	
ELEVATORS	120,154
PERIOTOME ROOTS ELEVATOR	43
PERRY TWEEZERS	52,53
PHYSIC EXTRACTING FORCEPS (AMERICAN PATTERN)	18
PIN & LIGATURE CUTTER	142
PIN & LIGATURE CUTTERS TC	139
PIN HOLDING PLIER TC	140
PIN-TWEEZERS	170
PLAIN MOUTH MIRRORS	49
PLANATOR	69
PLANATOR	69
PLASTER KNIFE	96
PLASTER SHEARS	124
PLASTIC FILLING INSTRUMENTS	93
PLIER STAND PLASTIC	144
PLIER STAND STAINLESS STEEL	144
PLIERS FOR ORTHODONTICS & PROSTHETICS	132to143
PLIERS STAND STAINLESS ROD (ALUMINUM ANODIZED)	144
PLUGGERS	56
PLUGGERS/CONDENSERS	87
POSITIONING 3 IMPLANTOLOGY	161



## DESCRIPTION PAGE#

POSITIVE POSTIONER .....	125
POSTERIOR BAND REMOVING PLIERS - LONG .....	141
POSTERIOR BAND REMOVING PLIERS - SHORT .....	141
POTTS 'T-HANDLE' ELEVATOR-LEFT .....	41
POTTS 'T-HANDLE' ELEVATOR-RIGHT .....	41
PRICHARD PERIODONTAL INSTRUMENTS .....	121
PROBE EXPLORERS .....	51
PRONG 3 CLASP ADJUSTABLE PLIER TC. ....	140
<b>Q</b>	
QUATRO DENTAL SYRINGES .....	27
<b>R</b>	
RASPATOR, PRICHARD .....	165
RASPATOR, RASPATORY .....	120
RASPATOR, WILLIGER .....	120
RECTANGULAR ARCH BENDING PLIERS .....	143
RETRACTOR SELDIN .....	103
RETRACTORS - MOUTH GAGS .....	99,100
RETRACTORS .....	101to103
RHODIUM MOUTH MIRRORS .....	49
RIBBON RETRACTORS .....	101
RIDGE MAPPING DOUBLE CALIPER .....	146
RING 2 DENTAL SYRINGES .....	27
ROCHESTER-KÖCHER HAEMOSTATIC FORCEPS .....	110
ROCHESTER-PEAN HAEMOSTATIC FORCEPS .....	110
ROOT CANAL PLUGGER .....	56
ROOT ELEVATOR .....	236to48
ROOT ELEVATORS SET OF 10 PCS .....	46
ROOT FRAGMENT FORCEPS .....	09,11
ROOT PICK ELEVATOR WITH GOLD FLEXIBLE POINTS .....	42
ROOT PLANNING FILES .....	119
ROOT PLANNING FILES & BONE FILES .....	119
ROOTS SPLINTER FORCEPS .....	10
ROSER-KÖNIG RETRACTORS - MOUTH GAGS .....	100
ROUND AND CONCAVE PLIER .....	139
ROUND ENDODONTIC BOXES .....	186
ROUND EXCAVATOR .....	86
ROUND TORQUE WRENCH UNIVERSAL .....	177
ROUTURIER EXTRACTING FORCEPS (ENGLISH PATTERN) .....	03
ROUTURIER EXTRACTING FORCEPS FOR LOWER MOLARS .....	03
RUBBER DAM CLAMPS .....	113
RUBBER DAM CLAMPS FORCEPS .....	111
RUBBER DAM CLAMPS KITS .....	112
RUBBER DAM FRAME .....	111
RUBBER DUM TEMPLATE .....	112
RULER .....	127
RULER WEDGE .....	127
RUSSIAN LONG TISSUE FORCEPS .....	170
RUSSIAN TISSUE FORCEPS .....	170
RYDER NEEDLE HOLDERS .....	106,107
<b>S</b>	
SAW BLADES .....	124
SCALER .....	59to67
SCALERS TRAYS .....	183
SCALPEL HANDLE STRAIGHT .....	123
SCALPEL HANDLES .....	123
SCHLEMMER ROOTS ELEVATOR .....	37
SCHMIDLIN PERIODONTAL INSTRUMENTS .....	122
SCHURE BAND SEATER .....	130
SCHWARZ PLIERS .....	139
SEPARATING ELASTIC PLIER .....	111
SELDIN PERIODONTAL INSTRUMENTS .....	122
SELDIN ROOT ELEVATORS .....	29,32
SELF LOCKING GROOVED .....	169
SELF-LOCKING TWEEZER .....	53
SEMKEN TAYLOR TWEEZERS .....	52
SENN MUELLER RETRACTOR .....	102
SERRATED PLUGGERS .....	84
SET OF 5 PIECES .....	171
SHEPHERD'S HOOK EXPLORER .....	54
SHORT IMPLANT DRILLS .....	176
SICKLE SCALERS .....	63
SIMPLEX RETRACTOR .....	100
SINUS ELEVATOR & MEMBRANE LIFT TIPS .....	164
SINUS IMPLANTOLOGY .....	156,161
SINUS LEFT ELEVATOR & MEMBRANE LIFT TIPS 3 SET OF 7 PCS .....	164
SINUS LEFT ELEVATOR SET OF 10 PCS .....	158
SINUS LIFT ELEVATOR .....	151,157
SINUS LIFT ELEVATORS SET OF 7 PCS WITH CASSETTE .....	157
SINUS LIFT INSTRUMENT .....	150to152,161
SINUSLIFT IMPLANTOLOGY .....	150,161
SIQVELAND RETAINERS .....	115
SLIM WEINGART PLIERS .....	141
SLIPPER TWEEZERS .....	128
SMAHA ELASTOMERIC LIGATURE PLACING FORCEPS .....	140
SMALL/MEDIUM BALL BURNISHER .....	149
SOFT BRUSHING KIT SET OF 6 PCS .....	163
SOFT WIRE AND LIGATURE CUTTER .....	135
SOFT WIRE AND LIGATURE CUTTER, STANDARD .....	135
SPATULAS .....	73
SPATULAS ROUNDED AND SHARP .....	72
SPECIAL INOX .....	124
SPECIAL INOX WAX KNIVES .....	96
SPENCER GUM SCISSORS .....	105
SPIRIT LAMP .....	186
SPLINTER FORCEPS .....	10
SPOON AND PUSHER (TRINOVO) .....	167
STANDARD LIGATURE CUTTER TC. ....	139
STAR TORQUE WRENCH UNIVERSAL .....	177
STERILIZING BOXES & INSTRUMENTS TRAYS .....	184
STERILIZING MESH TRAY .....	190
STERNBERG RETRACTORS .....	99
STIEGLITZ ROOT FRAGMENTS .....	10
STIEGLITZ SPLINTER FORCEPS .....	10
STOCKES RUBBER DAM CLAMPS FORCEPS .....	111
STOP PLIERS V-BEED .....	137
STRAIGHT DIRECT BOND BRACKET REMOVER TC. ....	140
STRIP SAW .....	125
SUCTION CANNULA KIT WITH 3 NEEDLES .....	178
SUCTION NEEDLE .....	178
SUCTION PIPE .....	178
SUCTION TUBES .....	178
SURGICAL TWEEZERS .....	52

## DESCRIPTION PAGE#

SURGICAL BALL HOOK CRIMPING PLIERS, ANGLED .....	137
SURGICAL BALL HOOK CRIMPING PLIERS, STRAIGHT .....	137
SURGICAL CHISELS .....	162
SUTURE PLIERS SUTURE FORCEPS .....	169
SWEDISH TYPE DENTAL SYRINGES .....	27
SYNDEMOTOMES ROOTS ELEVATOR .....	43
<b>T</b>	
TAMPER .....	166
TANNER FILLING INSTRUMENTS .....	89
TARTAR REMOVER INSTRUMENTS SOLID HANDLE .....	67
TAYLOR SCALER .....	63
THICK EXPLORERS .....	54
THREE JAW PLIERS .....	143
TISSUE GRAFT FORCEP SERRATED TEETH .....	169
TISSUE MEMBRANE FORCEPS .....	169,170
TISSUE PUNCH .....	173
TISSUE PUNCH FORCEPS TO REMOVE TISSUE AFTER USING PUNCH .....	170
TISSUE PUNCH SET OF FIVE PIECES .....	173
TISSUE PUNCH STRAIGHT & CURVED .....	173
TISSUE PUNCH WITH PIN SET OF FOUR PIECES .....	173
TITANIUM LOCKING PLIER .....	169
TITANIUM PERIOSTEAL ELEVATOR FOR IMPLAN .....	122
TOFFLEMIRE-JUNIER SIQVELAND RETAINERS .....	115
TOFFLEMIRE-SENIOR SIQVELAND RETAINERS .....	115
TOMAS EXTRACTING FORCEPS (AMERICAN PATTERN) .....	17,22
TOMNS NEEDLE HOLDERS .....	109
TORQUE WRENCH & RATCHET .....	177
TORQUING PLIERS SET .....	137
TOWNER-JAQUETTE SCALER .....	63
TREPHINE .....	175
TREPHINE DRILL SET OF EIGHT PIECES .....	175
TRINOVO HANDLE .....	167
TRIO DENTAL SYRINGES .....	27
TRIPLE-ANGLED BACK ACTION EXCAVATOR .....	86
TWEED / ANGEL FORMING AND TORQUING PLIERS .....	134
TWEED / ANGEL RECTANGULAR ARCH FORMING AND .....	
TORQUING PLIERS .....	137
TWEED / ANGLE RECTANGULAR ARCH FORMING & TORQUING PLIERS .....	133
TWEED LOOP FORMING PLIERS .....	132,133,143
TWEEZERS .....	52,53
TWEEZERS EXPLORERS .....	51
TWEL-ON ELASTIC MODULE INSTRUMENT .....	130
TYPE C DENTAL SYRINGES .....	27
<b>U</b>	
UNIQUE RETRACTORS .....	102
UNIVERSAL CROWN REMOVER .....	114
UNIVERSAL CURETTES .....	63
UNIVERSAL CUT & HOLD DISTAL END CUTTER .....	142
UNIVERSAL DOLPHIN STYLE WIRE BENDING & CUTTING PLIERS .....	132
UNIVERSAL EXTRACTING FORCEPS (AMERICAN PATTERN) .....	22
UNIVERSAL MINI-ELEVATOR FOR FRAGMENTS .....	34
UNIVERSAL NEEDLE HOLDERS .....	106
UNIVERSITY OF MICHIGAN EXPLORERS .....	55
UNIVERSITY OF NORTH CAROLINA EXPLORER .....	55
UPPER ROOT ELEVATOR WITH HELICOIDAL TIP .....	31
US ARMY RETRACTORS .....	102
UTILITY PLIER WEINGART TC. ....	140
<b>V</b>	
V-BEND STOP .....	139
V-BEND STOP PLIER TC. ....	139
VERNIER GAUGE .....	127
VISTA TUNNELING INSTRUMENTS SET .....	155
<b>W</b>	
W BARRY ROOTS ELEVATOR .....	41
WAHL BONE FILES .....	119
WAKAI HEAT CARRIERS .....	57
WALDSAVHS WIRE BENDING AND CUTTING PLIERS .....	134
WANGEN HOLDER .....	99
WARD FILLING INSTRUMENTS .....	80
WATER SYRINGE .....	116
WAX KNIVES .....	96
WAY 6 ADJUSTABLE ANGLED SCALPEL HANDLE .....	123
WEIDER RETRACTOR .....	99
WEINGART PLIER .....	139
WEINGART PLIER MEDIUM .....	132,134
WEINGART PLIERS .....	141
WEINGART UTILITY PLIERS .....	136
WEINGART-MINI UTILITY PLIERS .....	136
WEITLANER RETRACTORS - MOUTH GAGS .....	100
WERDELSTADT SCALER .....	67
WESTCOTT BURNISHERS .....	68
WESTCOTT FILLING INSTRUMENTS .....	93
WESTON CEMENT SPATULAS .....	95
WHITE BURNISHERS .....	68
WIDE SIQVELAND RETAINERS .....	115
WILAND SCALER .....	65
WILKINS/TUFTS EXPLORER .....	54
WILLIAMS EXPLORERS .....	55
WILLIAMS FILLING INSTRUMENTS .....	81
WINTER EXTRACTING FORCEPS (AMERICAN PATTERN) .....	12
WINTER ROOTS ELEVATOR .....	41
WIRE BENDING & LOOP FORMING PLIERS .....	132
WIRE BENDING AND LOOP FORMING PLIERS ANGLED (BIRD BEAK) .....	136
WISDOM EXTRACTING FORCEPS .....	03
WISDOM ROOT ELEVATOR .....	09
WITZEL FORCEPS WITH ANATOMICAL HANDLE SET OF 3 PCS .....	09
WITZEL FORCEPS WITH GOLD SET OF 3 PCS .....	09
WITZEL FORCEPS WITH HOLE AND SCREW PATTERN SET OF 3 PCS .....	09
WOODEN HANDLE WAX KNIVES .....	96
<b>X</b>	
X RAY FILM HANGERS .....	94
<b>Y</b>	
YOUNG TONGUE FORCEPS .....	110
YOUNG WIRE BENDING & LOOP FORMING PLIERS .....	132
YOUNGER GOOD SCALER .....	63
<b>Z</b>	
ZAHLE CEMENT SPATULAS .....	95

**NEW EDITION**

# **DENTAL**

## *INSTRUMENTS*

Extraction Sets  
Extracting Forceps  
Root Elevators  
Bone Rongeurs  
Orthodontic Pliers  
Scalers  
Impression Trays



**SMILES & STYLES**  
**ENTERPRISES**

**MANUFACTURER & EXPORTER OF SURGICAL, DENTAL AND BEAUTY TOOLS IN SIALKOT**



